

TRANSISTOR (NPN)

FEATURES

- Compliment to PXT8550

MARKING: Y1

MAXIMUM RATINGS (T_a=25°C unless otherwise noted)

Symbol	Parameter	Value	Unit
V _{CBO}	Collector-Base Voltage	40	V
V _{CEO}	Collector-Emitter Voltage	25	V
V _{EBO}	Emitter-Base Voltage	5	V
I _C	Collector Current -Continuous	1.5	A
P _C	Collector Power dissipation	0.5	W
R _{θJA}	Thermal Resistance From Junction To Ambient	250	°C/W
T _J	Storage Temperature	150	°C
T _{stg}	Storage Temperature	-55~150	°C

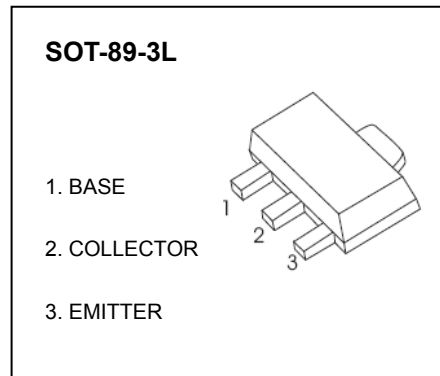

ELECTRICAL CHARACTERISTICS (T_a=25°C unless otherwise specified)

Parameter	Symbol	Test conditions	Min	Typ	Max	Unit
Collector-base breakdown voltage	V _{(BR)CBO}	I _C =100μA, I _E =0	40			V
Collector-emitter breakdown voltage	V _{(BR)CEO}	I _C =0.1mA, I _B =0	25			V
Emitter-base breakdown voltage	V _{(BR)EBO}	I _E =100μA, I _C =0	5			V
Collector cut-off current	I _{CBO}	V _{CB} =40V, I _E =0			0.1	μA
Emitter cut-off current	I _{CEO}	V _{CE} =20V, I _E =0			0.1	μA
Emitter cut-off current	I _{EBO}	V _{EB} =5V, I _C =0			0.1	μA
DC current gain	h _{FE(1)}	V _{CE} =1V, I _C =100mA	85		400	
	h _{FE(2)}	V _{CE} =1V, I _C =800mA	40			
Collector-emitter saturation voltage	V _{CE(sat)}	I _C =800mA, I _B =80mA			0.5	V
Base-emitter saturation voltage	V _{BE(sat)}	I _C =800mA, I _B =80mA			1.2	V
Base-emitter voltage	V _{BE}	V _{CE} =1V, I _C =10mA			1	V
Base-emitter positive favor voltage	V _{BEF}	I _B =1A			1.55	V
Transition frequency	f _T	V _{CE} =10V, I _C =50mA, f=30MHz	100			MHz
output capacitance	C _{ob}	V _{CB} =10V, I _E =0, f=1MHz			15	pF

CLASSIFICATION OF h_{FE(1)}

Rank	B	C	D	D3
Range	85-160	120-200	160-300	300-400



Typical Characteristics

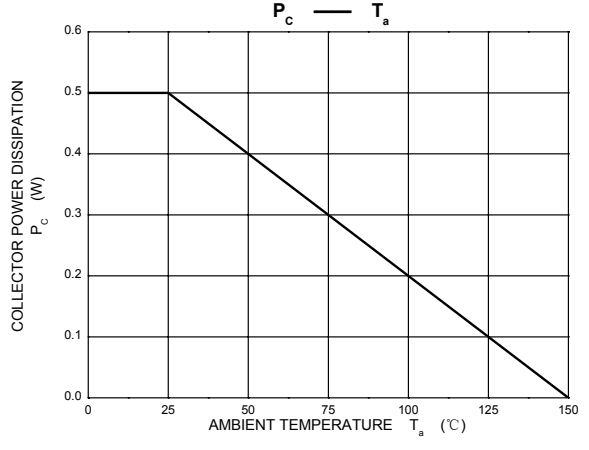
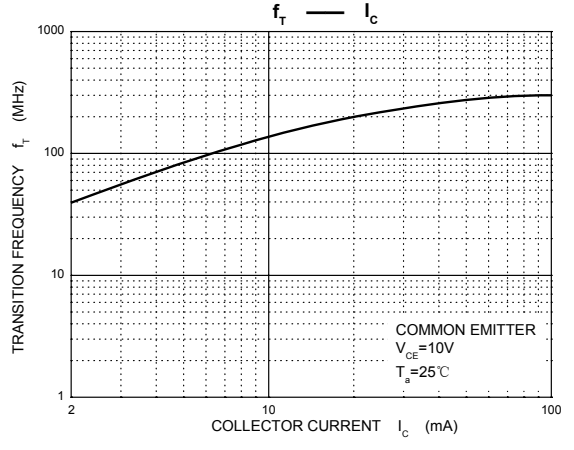
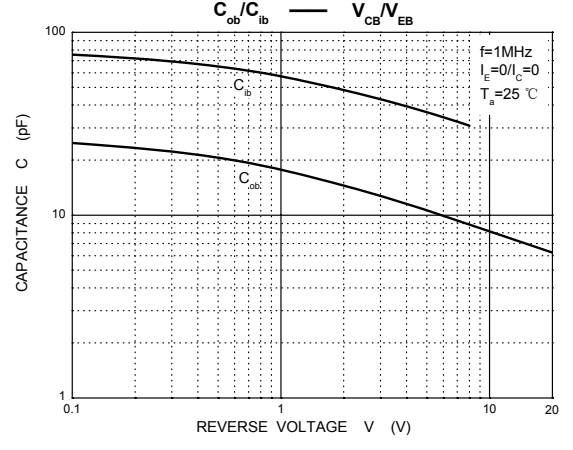
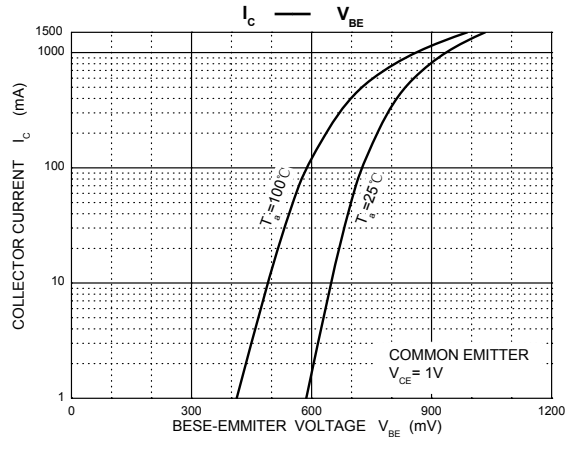
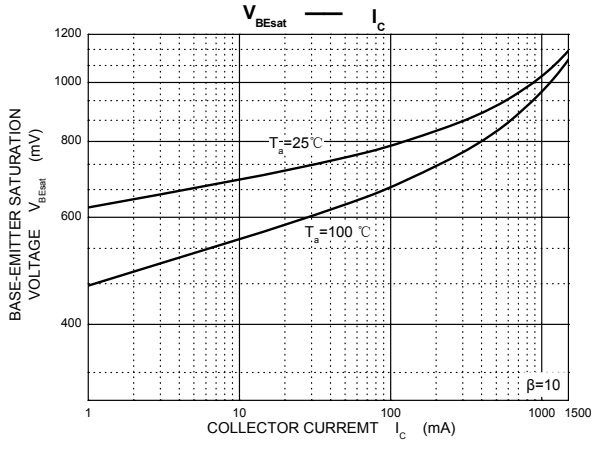
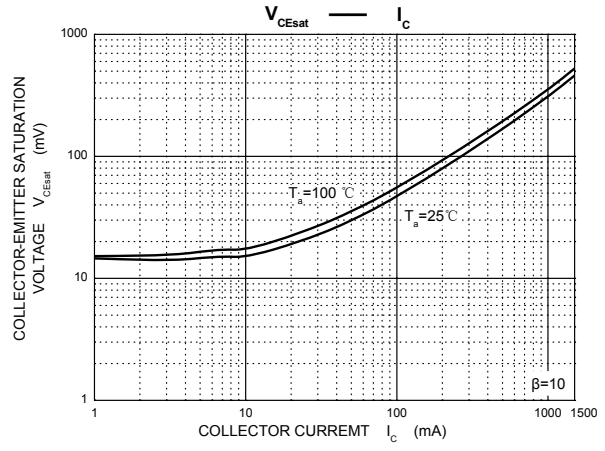
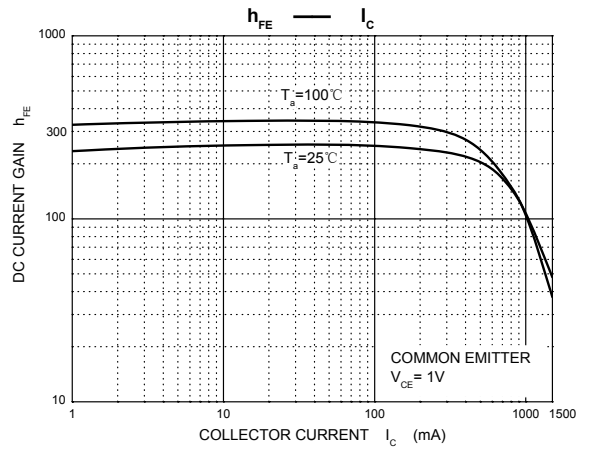
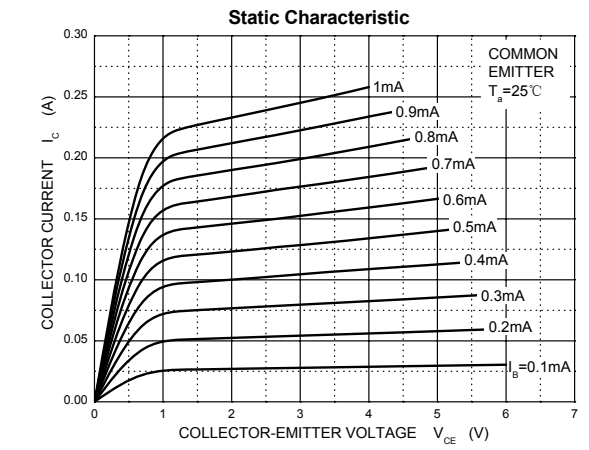

SOT-89-3L Package Outline Dimensions

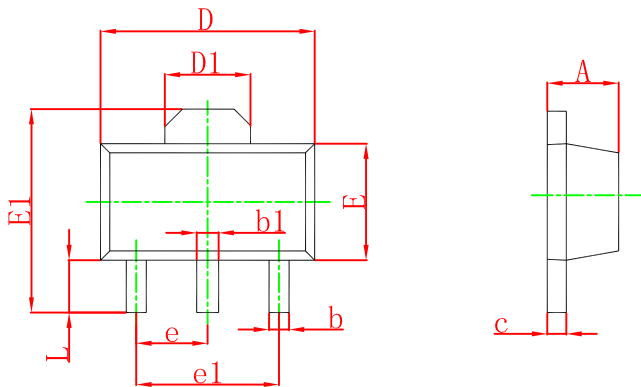

Symbol	Dimensions In Millimeters		Dimensions In Inches	
	Min	Max	Min	Max
A	1.400	1.600	0.055	0.063
b	0.320	0.520	0.013	0.020
b1	0.400	0.580	0.016	0.023
c	0.350	0.440	0.014	0.017
D	4.400	4.600	0.173	0.181
D1	1.550 REF.		0.061 REF.	
E	2.300	2.600	0.091	0.102
E1	3.940	4.250	0.155	0.167
e	1.500 TYP.		0.060 TYP.	
e1	3.000 TYP.		0.118 TYP.	
L	0.900	1.200	0.035	0.047

SOT-89-3L Suggested Pad Layout

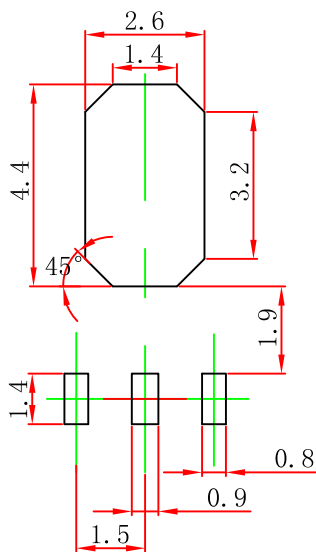

Note:

1. Controlling dimension: in millimeters.
2. General tolerance: $\pm 0.05\text{mm}$.
3. The pad layout is for reference purposes only.