

TRANSISTOR (NPN)

FEATURES

Driver transistor

MARKING :1H

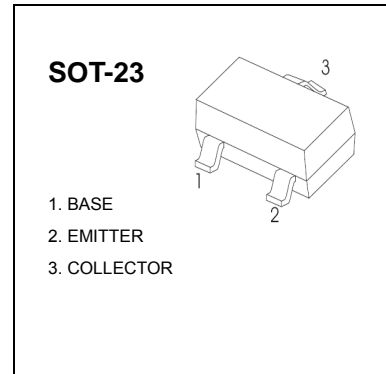

MAXIMUM RATINGS (T_a=25°C unless otherwise noted)

Symbol	Parameter	Value	Unit
V _{CB0}	Collector-Base Voltage	60	V
V _{CEO}	Collector-Emitter Voltage	60	V
V _{EBO}	Emitter-Base Voltage	4	V
I _C	Collector Current	500	mA
P _C	Collector Power Dissipation	300	mW
R _{θJA}	Thermal Resistance From Junction To Ambient	417	°C/W
T _J	Junction Temperature	150	°C
T _{stg}	Storage Temperature	-55~+150	°C

ELECTRICAL CHARACTERISTICS (T_a=25°C unless otherwise specified)

Parameter	Symbol	Test conditions	Min	Typ	Max	Unit
Collector-base breakdown voltage	V _{(BR)CBO}	I _C = 100μA, I _E =0	60			V
Collector-emitter breakdown voltage	V _{(BR)CEO}	I _C = 1mA, I _B =0	60			V
Emitter-base breakdown voltage	V _{(BR)EBO}	I _E =100μA, I _C =0	4			V
Collector cut-off current	I _{CBO}	V _{CB} =60V, I _E =0			0.1	μA
Collector cut-off current	I _{CEO}	V _{CE} =60V, I _B =0			0.1	μA
Collector cut-off current	I _{EBO}	V _{EB} =3V, I _C =0			0.1	μA
DC current gain	h _{FE1}	V _{CE} =1V, I _C = 10mA	100		400	
	h _{FE2}	V _{CE} =1V, I _C = 100mA	100			
Collector-emitter saturation voltage	V _{CE(sat)}	I _C =100mA, I _B =10mA			0.25	V
Base-emitter voltage	V _{BE}	V _{CE} =1V, I _C = 100mA			1.2	V
Transition frequency	f _T	V _{CE} = 2V, I _C =10mA f=100MHz	100			MHz



Typical Characteristics

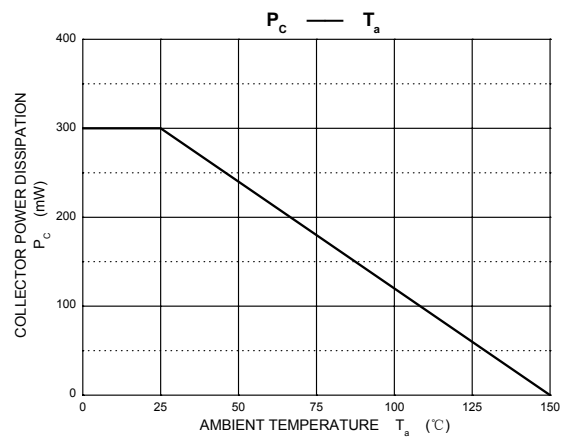
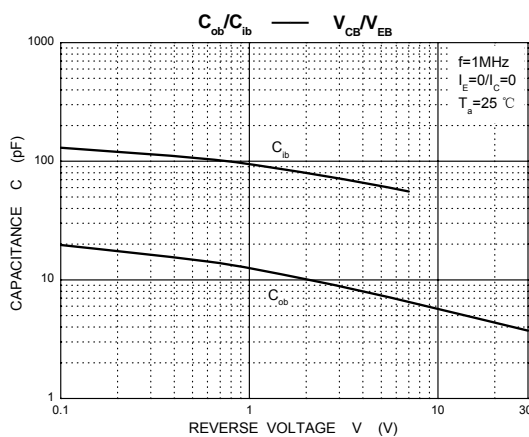
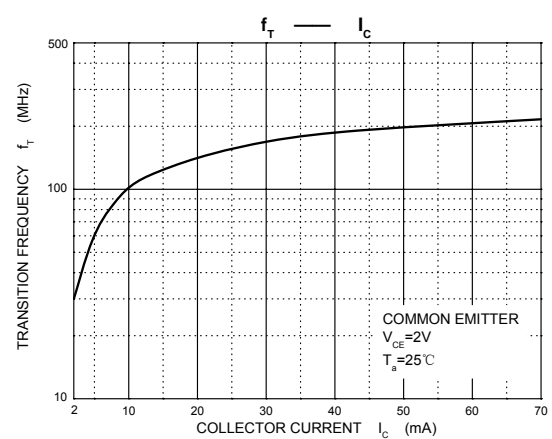
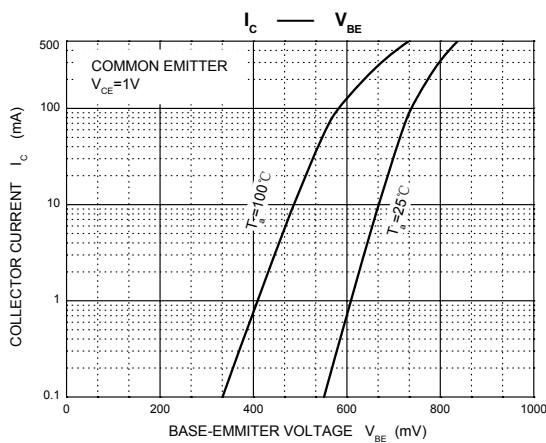
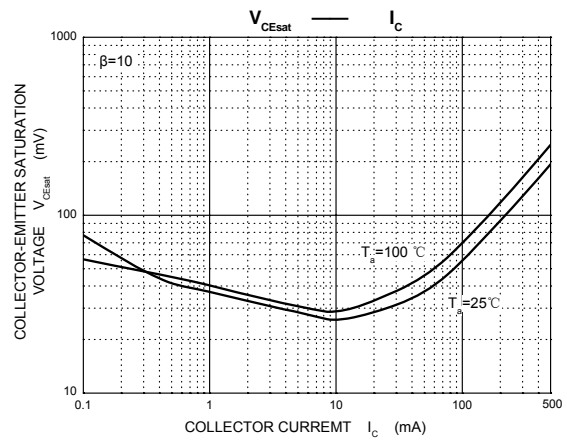
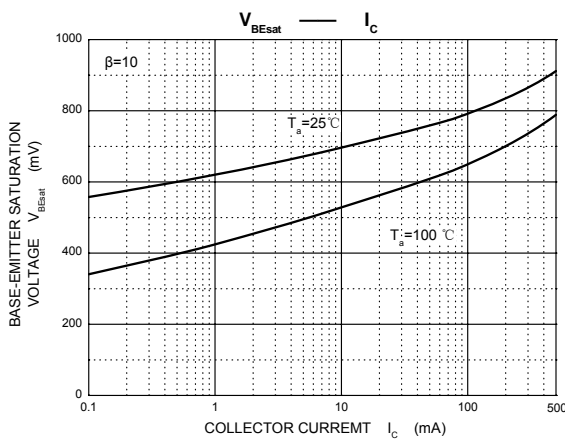
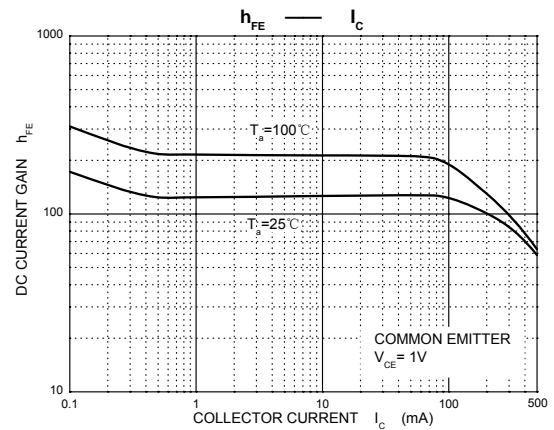
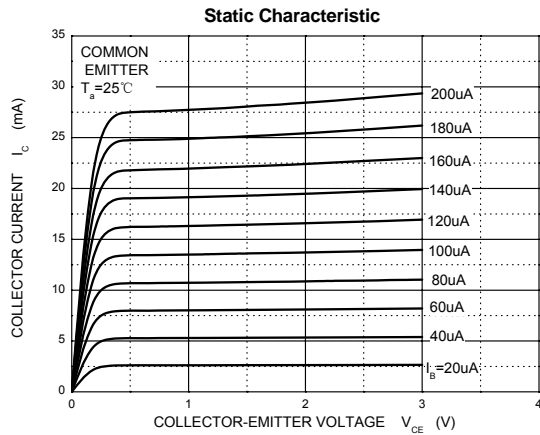

SOT-23 Package Outline Dimensions

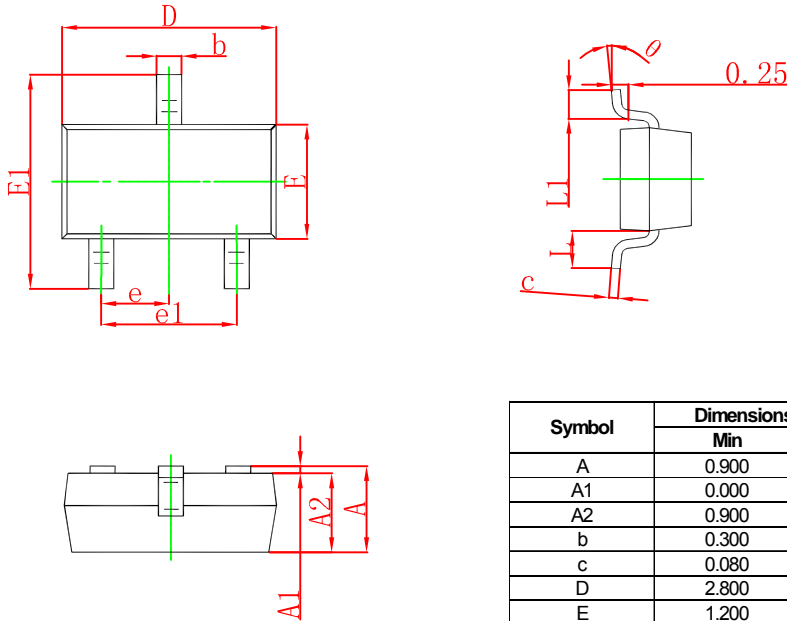

Symbol	Dimensions In Millimeters		Dimensions In Inches	
	Min	Max	Min	Max
A	0.900	1.150	0.035	0.045
A1	0.000	0.100	0.000	0.004
A2	0.900	1.050	0.035	0.041
b	0.300	0.500	0.012	0.020
c	0.080	0.150	0.003	0.006
D	2.800	3.000	0.110	0.118
E	1.200	1.400	0.047	0.055
E1	2.250	2.550	0.089	0.100
e	0.950 TYP		0.037 TYP	
e1	1.800	2.000	0.071	0.079
L	0.550 REF		0.022 REF	
L1	0.300	0.500	0.012	0.020
θ	0°	8°	0°	8°

SOT-23 Suggested Pad Layout

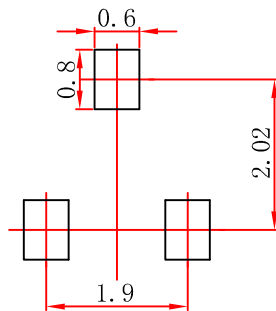

- Note:
1. Controlling dimension: in millimeters.
 2. General tolerance: ± 0.05 mm.
 3. The pad layout is for reference purposes only.