



SWITCHING DIODE

FEATURES

- Fast switching speed
- Surface mount package ideally suited for automatic insertion
- For general purpose switching applications
- High conductance

MARKING: KA3



Solid dot = Green molding compound device, if none, the normal device.

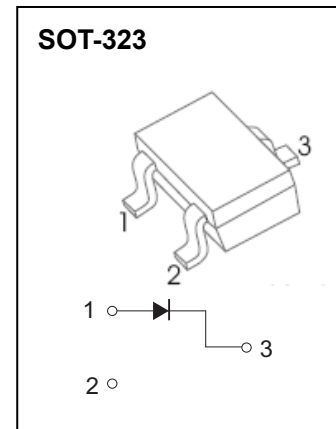

Maximum Ratings @Ta=25°C

Parameter	Symbol	Limit	Unit
Non-Repetitive Peak Reverse Voltage	V_{RM}	100	V
Peak Repetitive Peak Reverse Voltage	V_{RRM}	75	V
Working Peak Reverse Voltage	V_{RWM}		
DC Blocking Voltage	V_R		
RMS Reverse Voltage	$V_{R(RMS)}$	53	V
Forward Continuous Current	I_{FM}	500	mA
Average Rectified Output Current	I_O	250	mA
Non-Repetitive Peak Forward Surge Current @t=8.3ms	I_{FSM}	2.0	A
Power Dissipation	P_d	200	mW
Thermal Resistance from Junction to Ambient	$R_{\theta JA}$	625	°C/W
Storage Temperature	T_{STG}	-55 ~ +150	°C

Electrical Ratings @Ta=25°C

Parameter	Symbol	Min	Typ	Max	Unit	Conditions
Forward voltage	V_{F1}	0.62		0.72	V	$I_F=5mA$
	V_{F2}			0.855	V	$I_F=10mA$
	V_{F3}			1.0	V	$I_F=100mA$
	V_{F4}			1.25	V	$I_F=150mA$
Reverse current	I_{R1}			2.5	μA	$V_R=75V$
	I_{R2}			25	nA	$V_R=20V$
Capacitance between terminals	C_T			4	pF	$V_R=0V, f=1MHz$
Reverse recovery time	t_{rr}			4	ns	$I_F=I_R=10mA$ $I_{rr}=0.1 \times I_R, R_L=100\Omega$



Typical Characteristics

Forward Characteristics

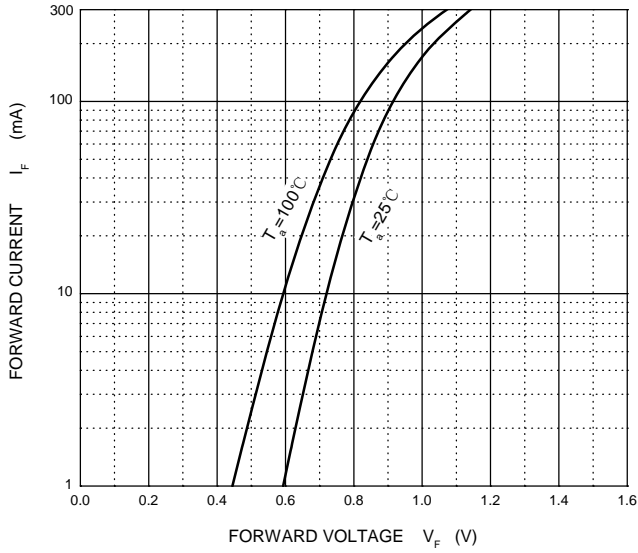

Reverse Characteristics

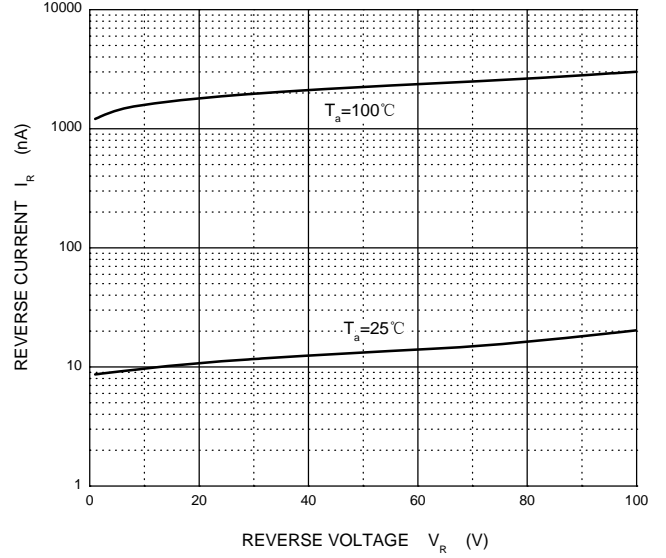

Capacitance Characteristics

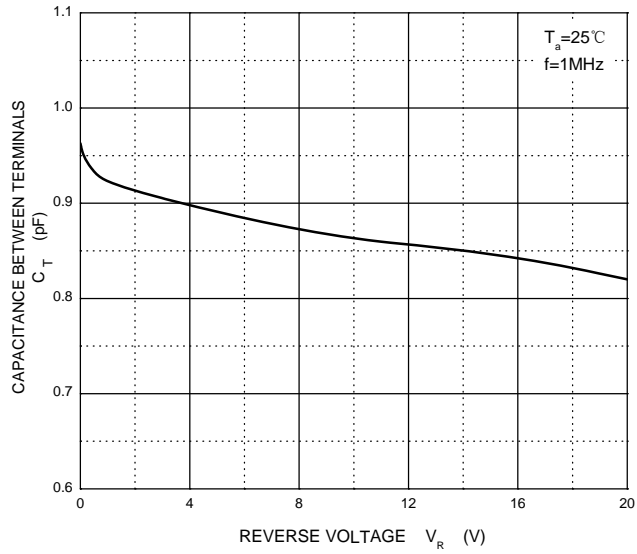

Power Derating Curve

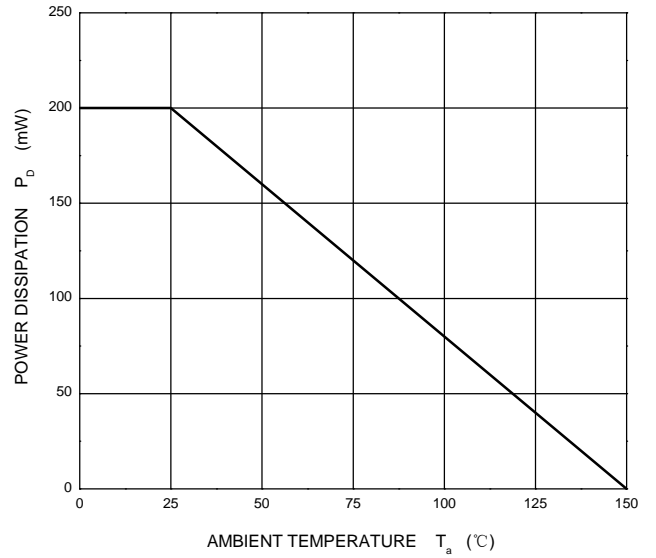

SOT-323 Package Outline Dimensions

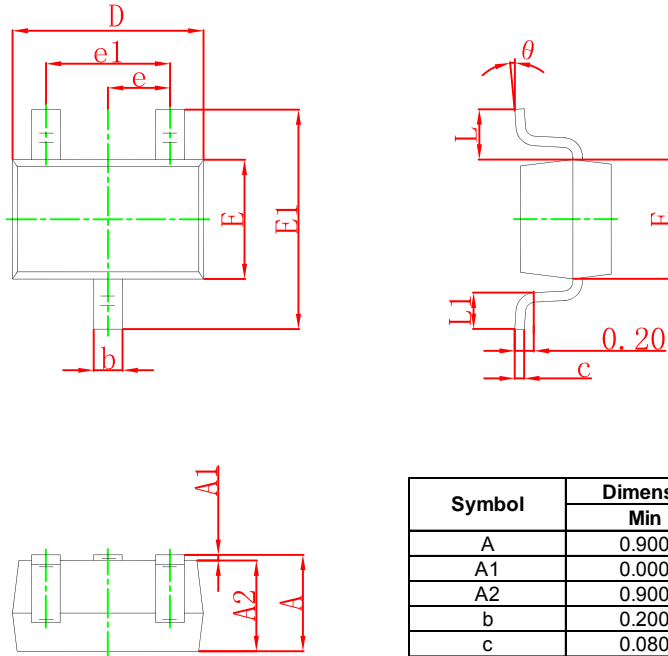

Symbol	Dimensions In Millimeters		Dimensions In Inches	
	Min	Max	Min	Max
A	0.900	1.100	0.035	0.043
A1	0.000	0.100	0.000	0.004
A2	0.900	1.000	0.035	0.039
b	0.200	0.400	0.008	0.016
c	0.080	0.150	0.003	0.006
D	2.000	2.200	0.079	0.087
E	1.150	1.350	0.045	0.053
E1	2.150	2.450	0.085	0.096
e	0.650 TYP		0.026 TYP	
e1	1.200	1.400	0.047	0.055
L	0.525 REF		0.021 REF	
L1	0.260	0.460	0.010	0.018
θ	0°	8°	0°	8°

SOT-323 Suggested Pad Layout

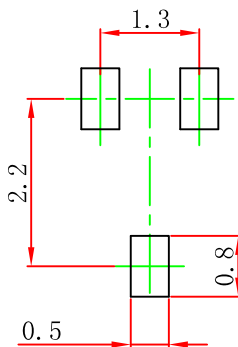

- Note:
1. Controlling dimension: in millimeters.
 2. General tolerance: ± 0.05 mm.
 3. The pad layout is for reference purposes only.