

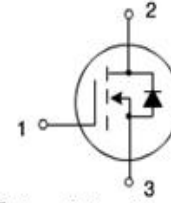

GDF12N65

N-Channel MOSFET

650V, 12A, $R_{DS(ON)} < 0.75 \Omega$



1. Gate 2. Drain 3. Source

General Description and Features

- Superior Avalanche Rugged Technology
- Robust Gate Oxide Technology
- Excellent Switching Characteristics
- Low Gate Charge
- Extended Safe Operating Area
- Lower $R_{DS(ON)}$: 0.6Ω (Typical) @ $V_{GS} = 10V$
- 100% Avalanche Tested
- Improved dv/dt Capability
- RoHS Compliant
- JEDEC Qualification



ABSOLUTE MAXIMUM RATINGS (Ta=25 °C)

Symbol	Parameter	Value	Unit
BV_{DSS}	Drain-Source Voltage	650	V
BV_{GSS}	Gate-Source Voltage	±30	V
I_D	Drain Current continuous Tc=25°C	12	A
I_{DM}	Drain Current - pulse	48	A
P_D	Power Dissipation	Tc=25°C	51
		Derated above 25°C	0.4
T_J, T_{STG}	Operating and Storage Temperature Range	-55~+150	°C
T_L	Maximum Lead Temperature for Soldering	260	°C

Thermal Characteristics

Symbol	Parameter	TO-220F	Unit
$R_{\theta JC}$	Thermal Resistance ,Junction to Case	2.43	°C/W
$R_{\theta JA}$	Thermal Resistance ,Junction to Ambient	62.5	°C/W

Electrical Characteristics(Tc=25°C unless otherwise specified)

Symbol	Parameter	Test conditions	min	typ	max	unit
Off state characteristics						
BV_{DSS}	Drain to Source breakdown Voltage	$I_D=250\mu A, V_{GS}=0V$	650			V
I_{DSS}	Zero Gate Voltage Drain Current	$V_{DS}=650V, V_{GS}=0V$			1	μA
I_{GSS}	Gate to Source Leakage Current	$V_{GS}=\pm 30V, V_{DS}=0V$			±100	nA



On state characteristics						
$V_{GS(th)}$	Gate to Source Threshold Voltage	$I_D=250\mu A, V_{GS}=V_{DS}$	2.0		4.0	V
$R_{DS(on)}$	Drain to Source On-Resistance	$I_D=6.0A, V_{GS}=10V$		0.6	0.75	Ω
G_{fs}	Forward Transconductance	$V_{DS}=15V, I_D=6A$		8.2		S
Dynamic characteristics						
C_{ISS}	Input Capacitance	$V_{DS}=25V, V_{GS}=0V, f=1MHz$		1480	1900	pF
C_{OSS}	Output Capacitance			200	270	pF
C_{RSS}	Reverse Transfer Capacitance			25	35	pF
Switching characteristics						
$t_{d(on)}$	Turn-On Delay Time	$V_{DD}=325V, I_D=10A$ $V_{GS}=10V, R_G=25\Omega$ (Note1,2)		30	70	ns
t_r	Rise Time			115	240	ns
$t_{d(off)}$	Turn-Off Delay Time			95	200	ns
t_f	Fall Time			85	180	ns
Q_g	Total Gate Charge	$V_{DD}=520V, I_D=12A$ $V_{GS}=10V$ (Note1,2)		42	54	nC
Q_{gs}	Gate to Emitter Charge			8.6	—	nC
Q_{gd}	Gate to Collector Charge			21	—	nC
Source Drain Diode Characteristics						
Symbol	Parameter	Test conditions	min	typ	max	unit
I_S	Maximum Continuous Drain-Source Diode Forward Current				12	A
I_{SM}	Maximum Pulsed Drain-Source Diode Forward Current				48	A
V_{SD}	Drain to Source Diode Forward Voltage	$I_S=12A, V_{GS}=0V$			1.4	V
t_{rr}	Diode Reverse Recovery Time	$I_S=12A, V_{GS}=0V$ $di/dt=100A/\mu S$		380		nS
Q_{rr}	Diode Reverse Recovery Charge				3.5	

Note:

1.Pulse Test :Pulse Width $\leq 300\mu s$, Duty cycle $\leq 2\%$

2.Essentially Independent of operating Temperature Typical Characteristics



Ratings and Characteristic Curves

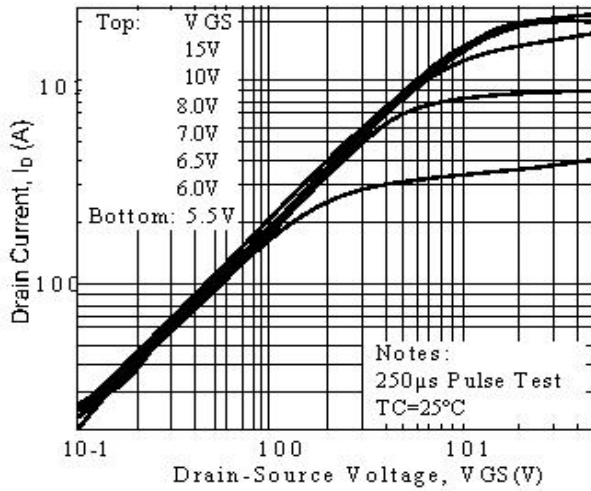

Fig.1 Output Characteristics

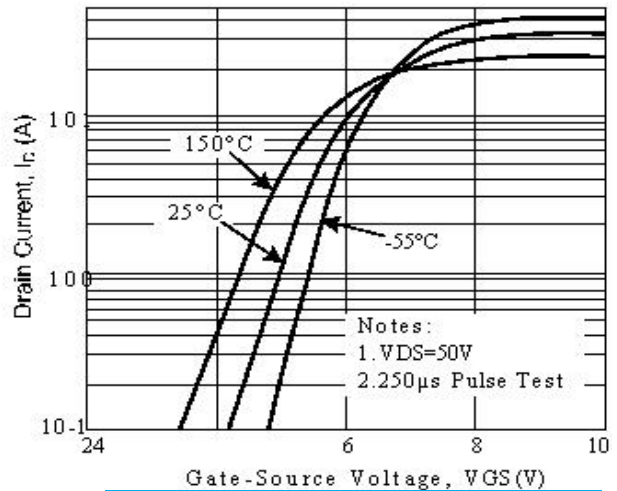

Fig.2 Transfer Characteristics

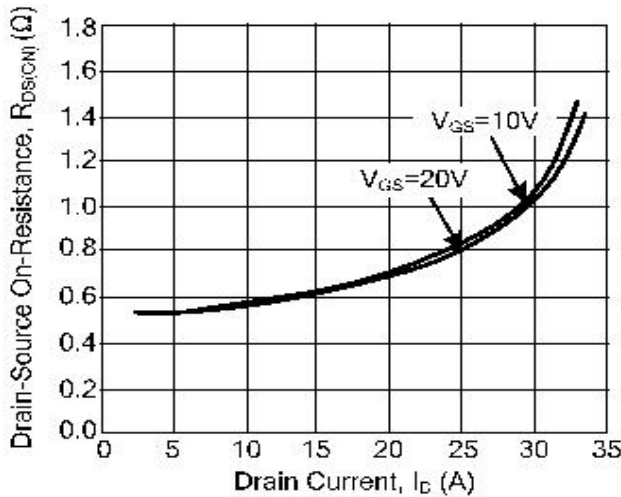

Fig.3 On-Resistance Variation vs. Drain Current and Gate Voltage

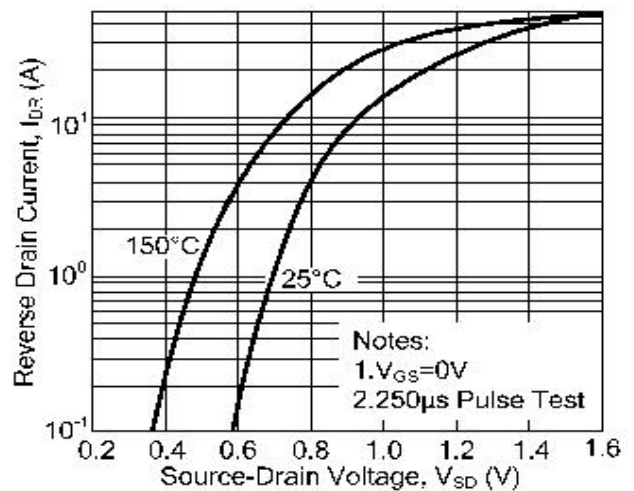

Fig.4 Body Diode Forward Voltage vs. Source Current and Temperature

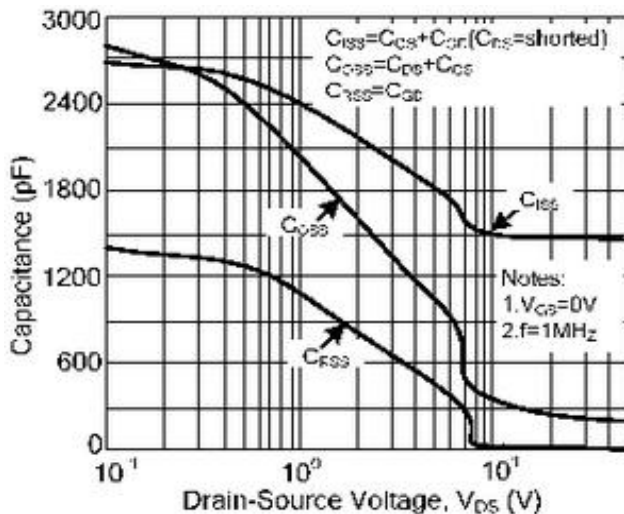

Fig.5 Capacitance Characteristics

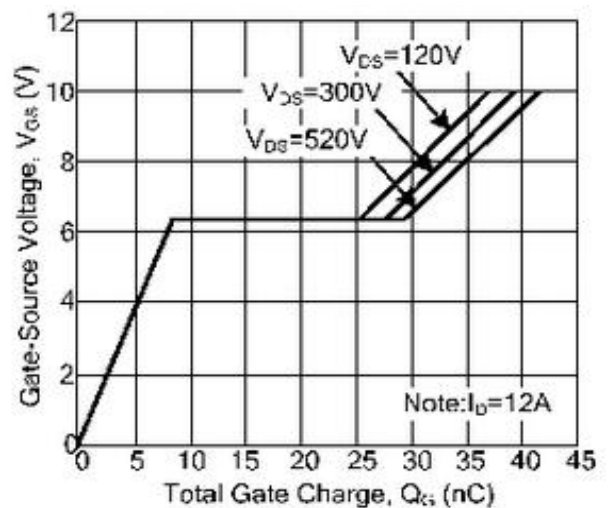

Fig.6 Gate Charge Characteristics

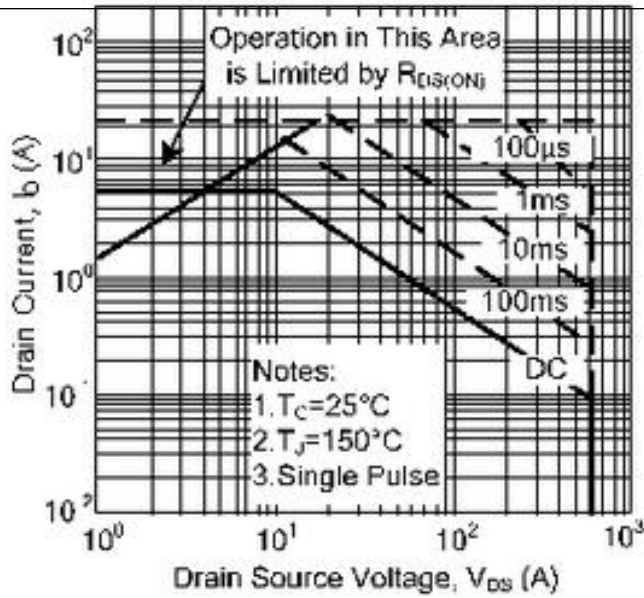

Fig.9 Maximum Safe Operating Area

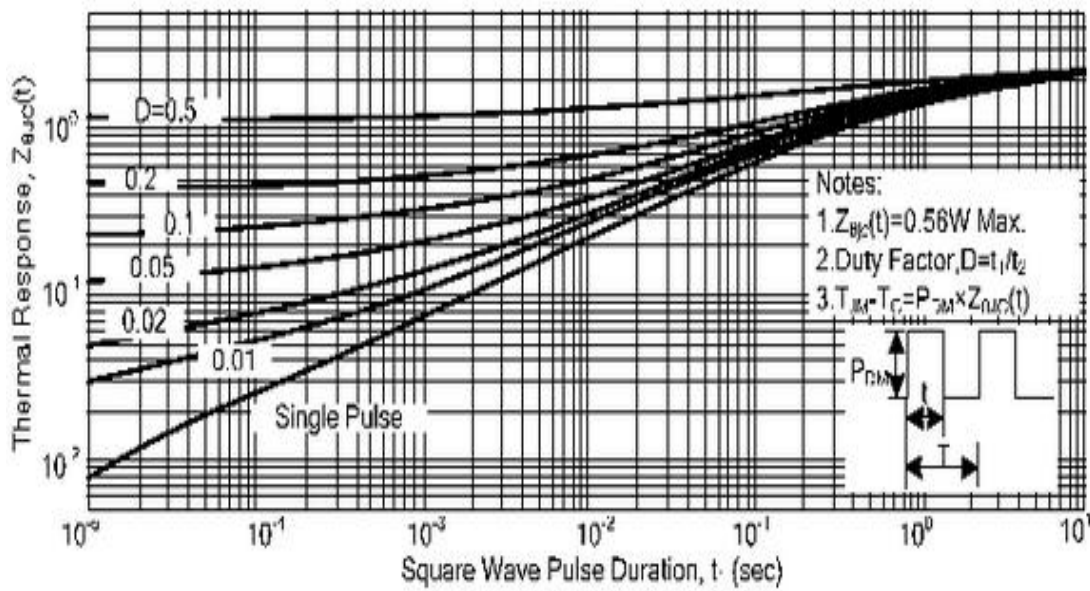
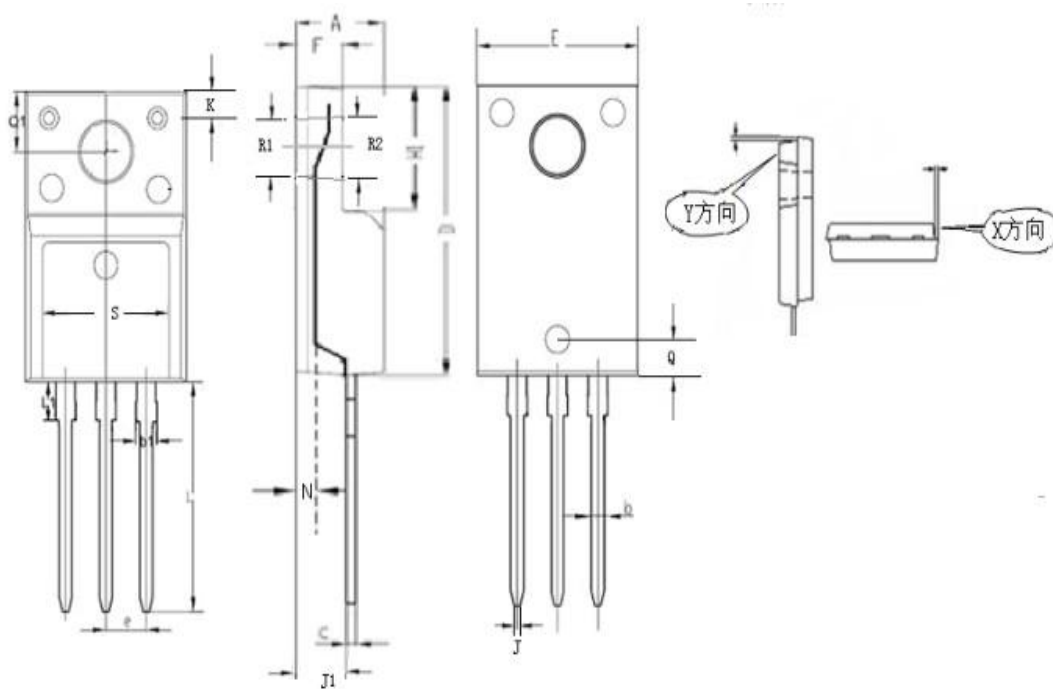

Fig.10 Transient Thermal Response Curve



TO-220F POD



SYMBOL	INCHES		MILLIMETERS		NOTES
	MIN	MAX	MIN	MAX	
A	0.178	0.194	4.53	4.93	
b	0.028	0.036	0.71	0.91	
C	0.018	0.024	0.45	0.6	
D	0.617	0.633	15.67	16.07	
E	0.392	0.408	9.96	10.36	
e	0.100 TYP.		2.54TYP.		
H1	0.256	0.272	6.5	6.9	
J1	0.101	0.117	2.56	2.96	
L	0.503	0.519	12.78	13.18	
φQ	0.117	0.133	2.98	3.38	
b1	0.045	0.055	1.15	1.39	
L1	0.114	0.13	2.9	3.3	
Q1	0.122	0.138	3.1	3.5	
N	0.016	0.024	0.4	0.6	
F	0.092	0.108	2.34	2.74	
J	0.013	0.017	0.32	0.43	
K	0.047	0.071	1.20	1.80	
R1	0.121	0.129	3.08	3.28	
R2	0.126	0.136	3.20	3.45	
Q	0.075	0.083	1.90	2.10	
S	0.311	0.319	7.90	8.10	
X	0	0.005	0	0.127	