

TGD N-Channel Enhancement Mode Power MOSFET

Description

The TGD6060 uses advanced trench technology and design to provide excellent $R_{DS(ON)}$ with low gate charge. It can be used in a wide variety of applications.

General Features

- $V_{DS} = 60V, I_D = 60A$
 $R_{DS(ON)} < 12m\Omega @ V_{GS}=10V$ (Typ:10.2m Ω)
- Special process technology for high ESD capability
- High density cell design for ultra low R_{dson}
- Fully characterized avalanche voltage and current
- Good stability and uniformity with high E_{AS}
- Excellent package for good heat dissipation

Application

- Power switching application
- Hard switched and High frequency circuits
- Uninterruptible power supply

100% UIS TESTED!

100% ΔV_d s TESTED!

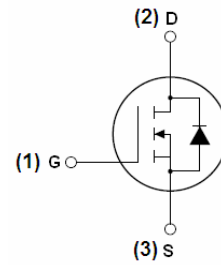

Schematic diagram

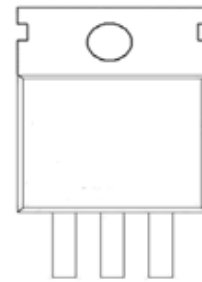

pin assignment

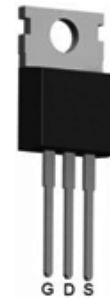

TO-220-3L top view

Package Marking and Ordering Information

Device Marking	Device	Device Package	Reel Size	Tape width	Quantity
TGD6060	TGD6060	TO-220-3L	-	-	-

Absolute Maximum Ratings ($T_C=25^\circ C$ unless otherwise noted)

Parameter	Symbol	Limit	Unit
Drain-Source Voltage	V_{DS}	60	V
Gate-Source Voltage	V_{GS}	± 20	V
Drain Current-Continuous	I_D	60	A
Drain Current-Continuous($T_C=100^\circ C$)	$I_D(100^\circ C)$	42	A
Pulsed Drain Current	I_{DM}	150	A
Maximum Power Dissipation	P_D	85	W



Derating factor		0.57	W/°C
Parameter	Symbol	Limit	Unit
Single pulse avalanche energy ^(Note 5)	E _{AS}	300	mJ
Operating Junction and Storage Temperature Range	T _J , T _{STG}	-55 To 175	°C

Thermal Characteristic

Thermal Resistance, Junction-to-Case ^(Note 2)	R _{θJc}	2	°C/W
--	------------------	---	------

Electrical Characteristics (TC=25°C unless otherwise noted)

Parameter	Symbol	Condition	Min	Typ	Max	Unit
Off Characteristics						
Drain-Source Breakdown Voltage	BV _{DSS}	V _{GS} =0V, I _D =250μA	60		-	V
Zero Gate Voltage Drain Current	I _{DSS}	V _{DS} =60V, V _{GS} =0V	-	-	1	μA
Gate-Body Leakage Current	I _{GSS}	V _{GS} =±20V, V _{DS} =0V	-	-	±100	nA
On Characteristics ^(Note 3)						
Gate Threshold Voltage	V _{GS(th)}	V _{DS} =V _{GS} , I _D =250μA	2	3	4	V
Drain-Source On-State Resistance	R _{DS(ON)}	V _{GS} =10V, I _D =30A	-	10.2	12	mΩ
Forward Transconductance	g _{FS}	V _{DS} =10V, I _D =20A	20	-	-	S
Dynamic Characteristics ^(Note 4)						
Input Capacitance	C _{iss}	V _{DS} =30V, V _{GS} =0V, F=1.0MHz	-	2800	-	PF
Output Capacitance	C _{oss}		-	430	-	PF
Reverse Transfer Capacitance	C _{rss}		-	190	-	PF
Switching Characteristics ^(Note 4)						
Turn-on Delay Time	t _{d(on)}	V _{DD} =30V, R _L =1Ω V _{GS} =10V, R _{GEN} =3Ω	-	15	-	nS
Turn-on Rise Time	t _r		-	35	-	nS
Turn-Off Delay Time	t _{d(off)}		-	44	-	nS
Turn-Off Fall Time	t _f		-	23	-	nS
Total Gate Charge	Q _g	V _{DS} =30V, I _D =30A, V _{GS} =10V	-	45	-	nC
Gate-Source Charge	Q _{gs}		-	10	-	nC
Gate-Drain Charge	Q _{gd}		-	15	-	nC
Drain-Source Diode Characteristics						
Diode Forward Voltage ^(Note 3)	V _{SD}	V _{GS} =0V, I _S =20A	-	-	1.2	V
Diode Forward Current ^(Note 2)	I _S	-	-	-	60	A
Reverse Recovery Time	t _{rr}	T _J = 25°C, I _F =10A di/dt = 100A/μs ^(Note3)	-	53	-	nS
Reverse Recovery Charge	Q _{rr}		-	51	-	nC
Forward Turn-On Time	t _{on}	Intrinsic turn-on time is negligible (turn-on is dominated by LS+LD)				

Notes:

1. Repetitive Rating: Pulse width limited by maximum junction temperature.
2. Surface Mounted on FR4 Board, t ≤ 10 sec.
3. Pulse Test: Pulse Width ≤ 300μs, Duty Cycle ≤ 2%.
4. Guaranteed by design, not subject to production
5. E_{AS} condition: T_j=25°C, V_{DD}=30V, V_G=10V, L=0.5mH, R_g=25Ω

Test Circuit

1) E_{AS} test Circuit

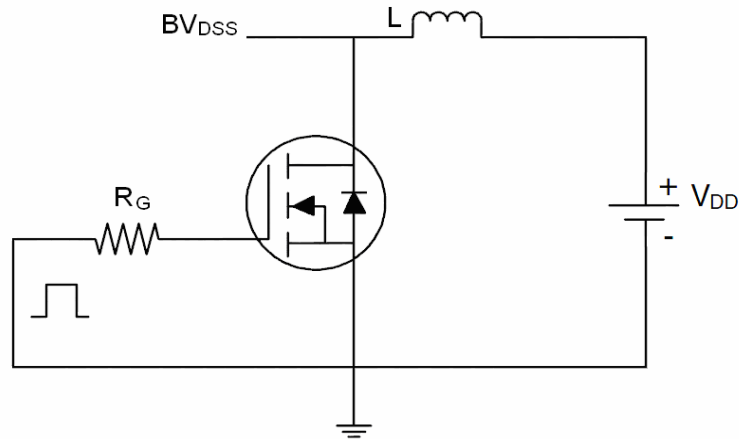

2) Gate charge test Circuit



3) Switch Time Test Circuit

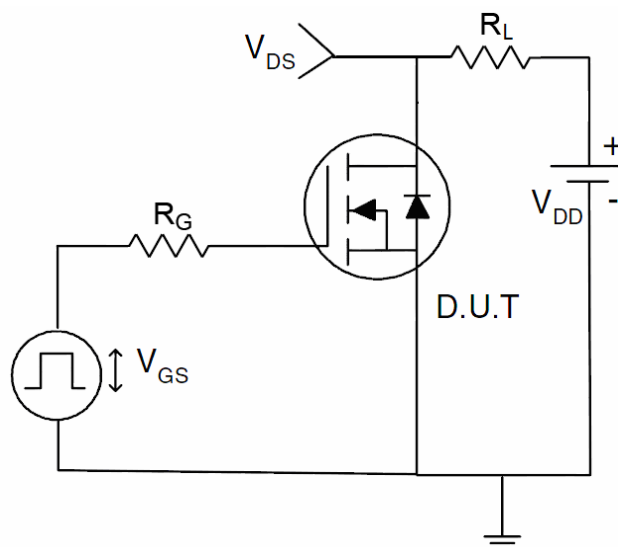

Typical Electrical and Thermal Characteristics (Curves)

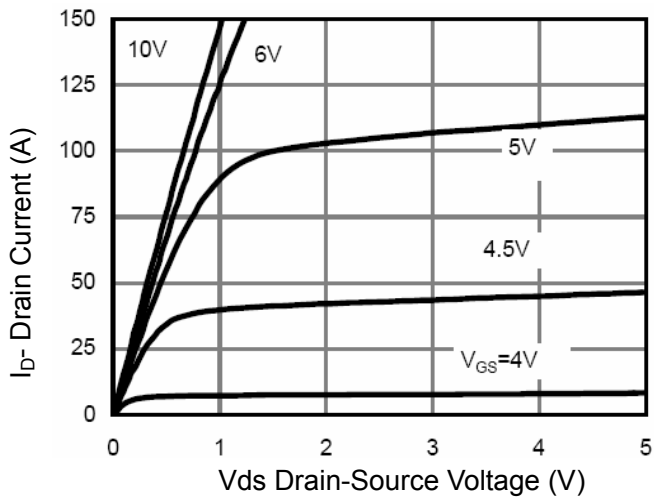

Figure 1 Output Characteristics

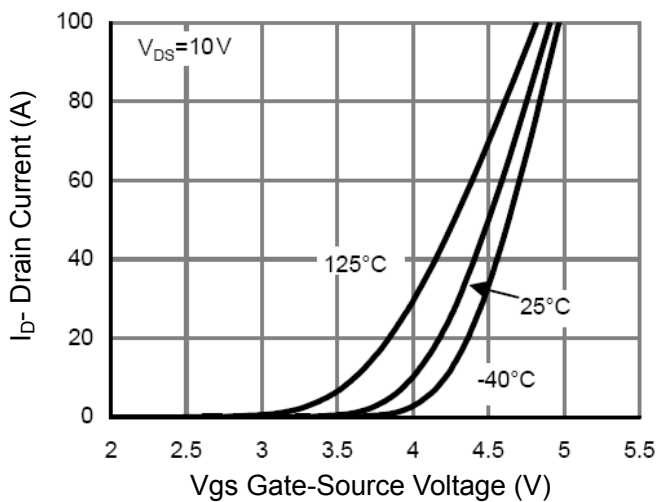

Figure 2 Transfer Characteristics

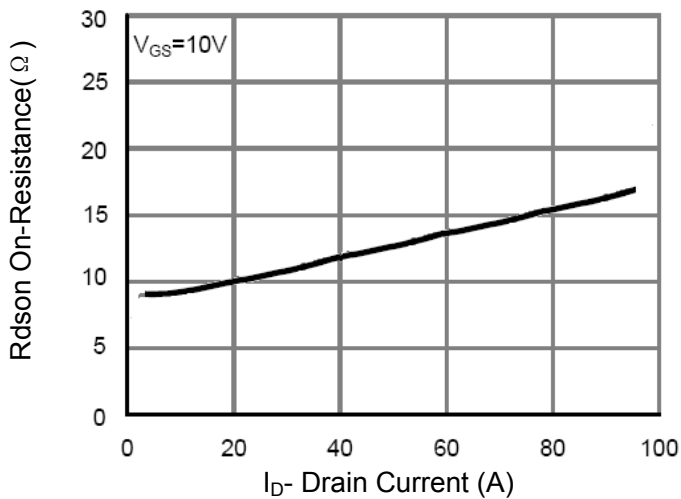

Figure 3 Rdson- Drain Current

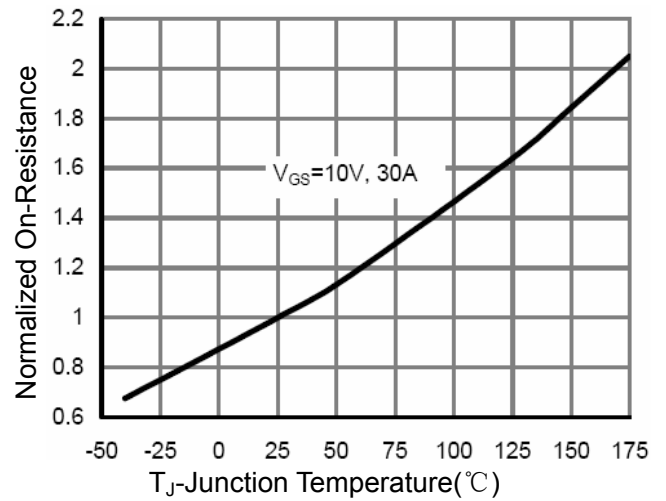

Figure 4 Rdson-Junction Temperature

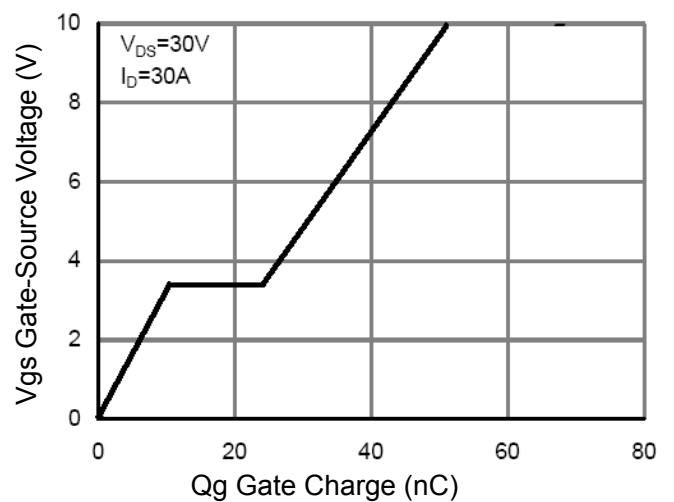

Figure 5 Gate Charge

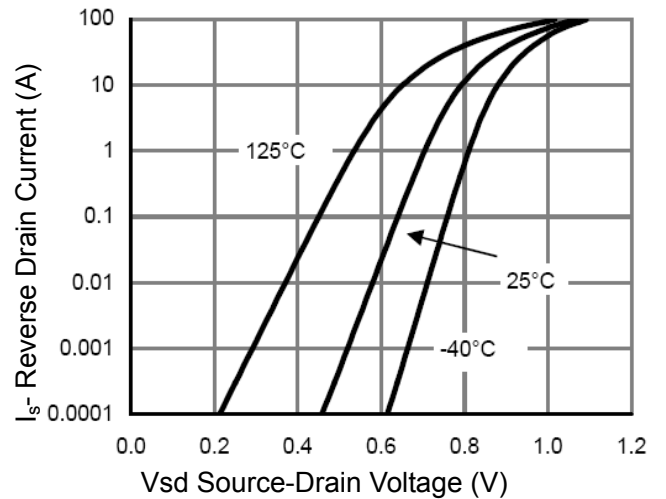

Figure 6 Source- Drain Diode Forward

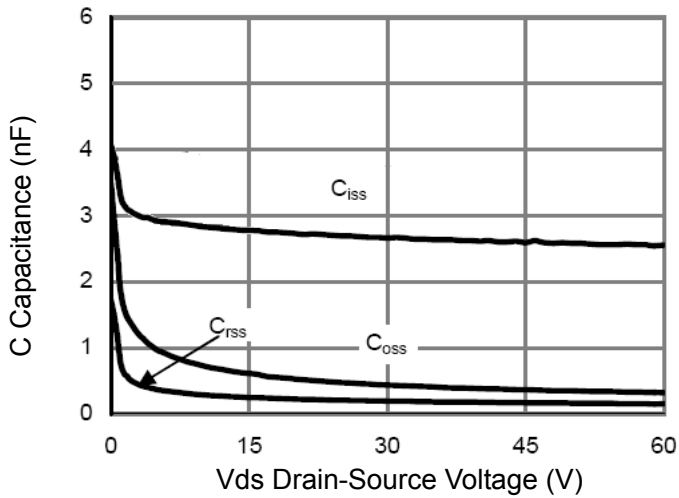

Figure 7 Capacitance vs Vds

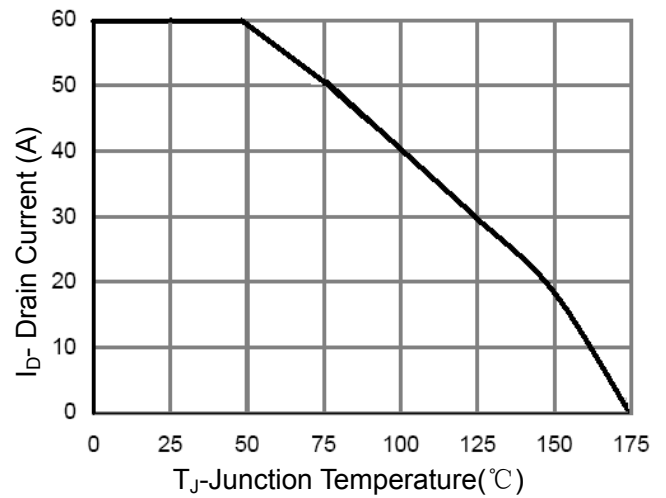

Figure 9 ID De-rating

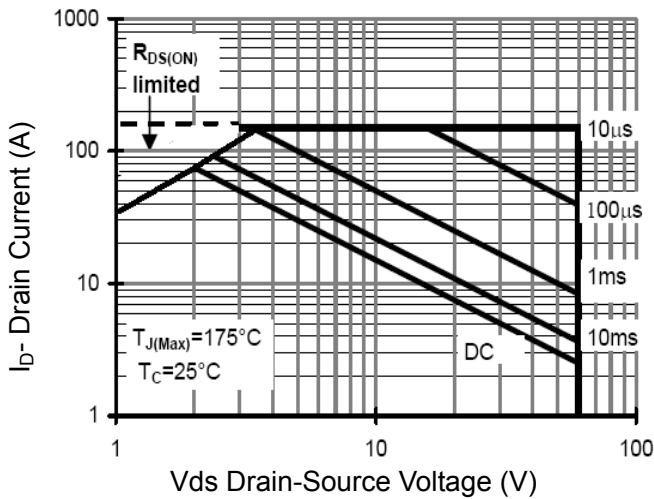

Figure 8 Safe Operation Area

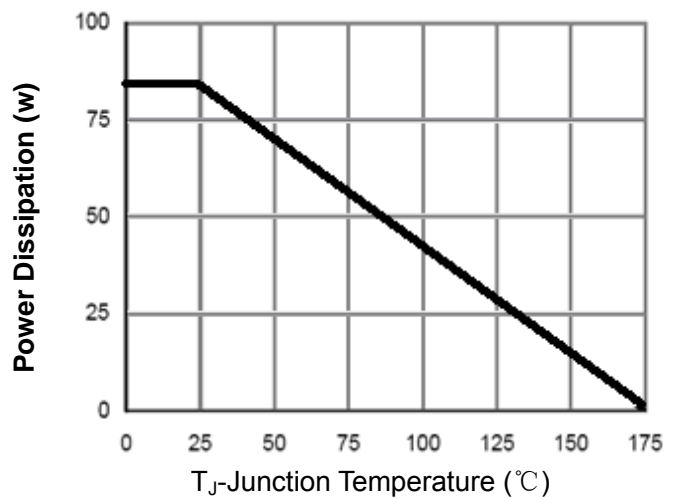

Figure 10 Power De-rating

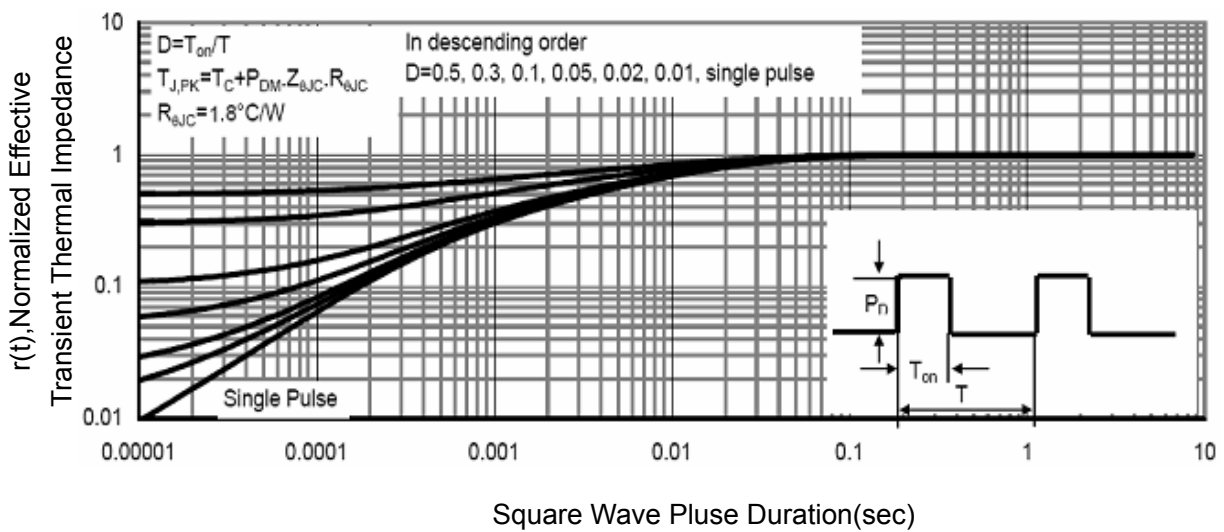
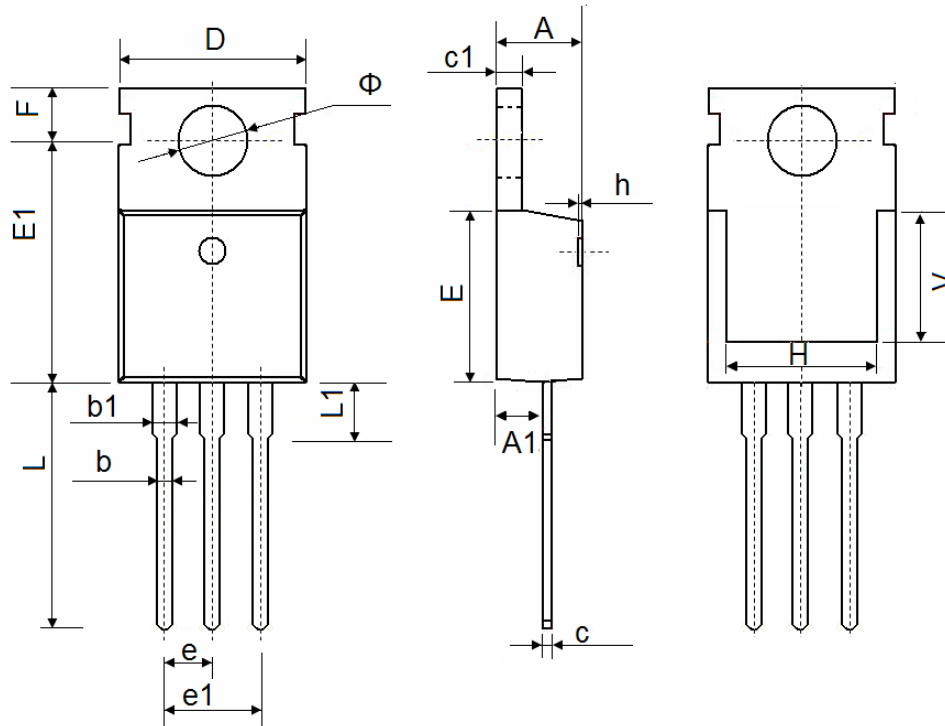

Figure 11 Normalized Maximum Transient Thermal Impedance

TO-220-3L Package Information



Symbol	Dimensions In Millimeters		Dimensions In Inches	
	Min.	Max.	Min.	Max.
A	4.400	4.600	0.173	0.181
A1	2.250	2.550	0.089	0.100
b	0.710	0.910	0.028	0.036
b1	1.170	1.370	0.046	0.054
c	0.330	0.650	0.013	0.026
c1	1.200	1.400	0.047	0.055
D	9.910	10.250	0.390	0.404
E	8.9500	9.750	0.352	0.384
E1	12.650	12.950	0.498	0.510
e	2.540 TYP.		0.100 TYP.	
e1	4.980	5.180	0.196	0.204
F	2.650	2.950	0.104	0.116
H	7.900	8.100	0.311	0.319
h	0.000	0.300	0.000	0.012
L	12.900	13.400	0.508	0.528
L1	2.850	3.250	0.112	0.128
V	7.500 REF.		0.295 REF.	
Φ	3.400	3.800	0.134	0.150