

TGD N-Channel Enhancement Mode Power MOSFET

Description

The TGD6009AS uses advanced trench technology and design to provide excellent $R_{DS(ON)}$ with low gate charge. It can be used in a wide variety of applications.

General Features

- $V_{DS} = 60V, I_D = 9A$
 $R_{DS(ON)} < 16m\Omega @ V_{GS}=10V$ (Typ:11m Ω)
 $R_{DS(ON)} < 18m\Omega @ V_{GS}=4.5V$ (Typ:13.5m Ω)
- High density cell design for ultra low Rdson
- Fully characterized avalanche voltage and current
- Low gate to drain charge to reduce switching losses

Application

- Power switching application
- Load switch

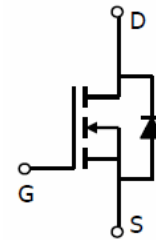

Schematic diagram

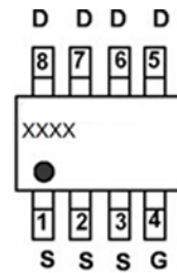

pin assignment

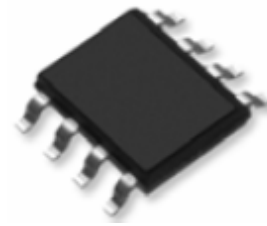

SOP-8 top view

Package Marking and Ordering Information

Device Marking	Device	Device Package	Reel Size	Tape width	Quantity
TGD6009AS	TGD6009AS	SOP-8	-	-	-

Absolute Maximum Ratings ($T_C=25^\circ C$ unless otherwise noted)

Parameter	Symbol	Limit	Unit
Drain-Source Voltage	V_{DS}	60	V
Gate-Source Voltage	V_{GS}	± 20	V
Drain Current-Continuous	I_D	9	A
Drain Current-Continuous($T_C=100^\circ C$)	$I_D(100^\circ C)$	6.4	A
Pulsed Drain Current	I_{DM}	36	A
Maximum Power Dissipation	P_D	2.6	W
Operating Junction and Storage Temperature Range	T_J, T_{STG}	-55 To 150	$^\circ C$

Thermal Characteristic

Thermal Resistance, Junction-to-Ambient ^(Note 2)	$R_{\theta JA}$	48	$^\circ C/W$
---	-----------------	----	--------------



Electrical Characteristics (TC=25°C unless otherwise noted)

Parameter	Symbol	Condition	Min	Typ	Max	Unit
Off Characteristics						
Drain-Source Breakdown Voltage	BV_{DSS}	$V_{GS}=0V, I_D=250\mu A$	60		-	V
Zero Gate Voltage Drain Current	I_{DSS}	$V_{DS}=60V, V_{GS}=0V$	-	-	1	μA
Gate-Body Leakage Current	I_{GSS}	$V_{GS}=\pm 20V, V_{DS}=0V$	-	-	± 100	nA
On Characteristics (Note 3)						
Gate Threshold Voltage	$V_{GS(th)}$	$V_{DS}=V_{GS}, I_D=250\mu A$	1.2	1.8	2.2	V
Drain-Source On-State Resistance	$R_{DS(on)}$	$V_{GS}=10V, I_D=9A$	-	11	16	m Ω
		$V_{GS}=4.5V, I_D=9A$	-	13.5	18	m Ω
Forward Transconductance	g_{FS}	$V_{DS}=5V, I_D=9A$	25	-	-	S
Dynamic Characteristics (Note 4)						
Input Capacitance	C_{iss}	$V_{DS}=30V, V_{GS}=0V,$ $F=1.0MHz$	-	2180	-	PF
Output Capacitance	C_{oss}		-	350	-	PF
Reverse Transfer Capacitance	C_{rss}		-	270	-	PF
Switching Characteristics (Note 4)						
Turn-on Delay Time	$t_{d(on)}$	$V_{DD}=30V, R_L=1\Omega$ $V_{GS}=10V, R_{GEN}=3\Omega$	-	8.5	-	nS
Turn-on Rise Time	t_r		-	6	-	nS
Turn-Off Delay Time	$t_{d(off)}$		-	30	-	nS
Turn-Off Fall Time	t_f		-	5	-	nS
Total Gate Charge	Q_g	$V_{DS}=30V, I_D=8A,$ $V_{GS}=10V$	-	58	-	nC
Gate-Source Charge	Q_{gs}		-	8	-	nC
Gate-Drain Charge	Q_{gd}		-	17	-	nC
Drain-Source Diode Characteristics						
Diode Forward Voltage (Note 3)	V_{SD}	$V_{GS}=0V, I_S=9A$	-	-	1.2	V
Diode Forward Current (Note 2)	I_S	-	-	-	9	A
Reverse Recovery Time	t_{rr}	$T_J = 25^\circ C, I_F=9A$ $di/dt = 100A/\mu s$ (Note 3)	-	30	-	nS
Reverse Recovery Charge	Q_{rr}		-	44	-	nC

Notes:

1. Repetitive Rating: Pulse width limited by maximum junction temperature.
2. Surface Mounted on FR4 Board, $t \leq 10$ sec.
3. Pulse Test: Pulse Width $\leq 300\mu s$, Duty Cycle $\leq 2\%$.
4. Guaranteed by design, not subject to production

Test Circuit

1) E_{AS} test Circuit

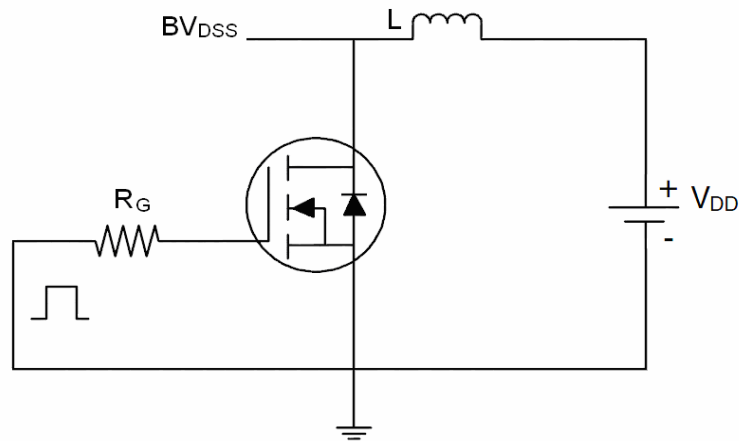

2) Gate charge test Circuit

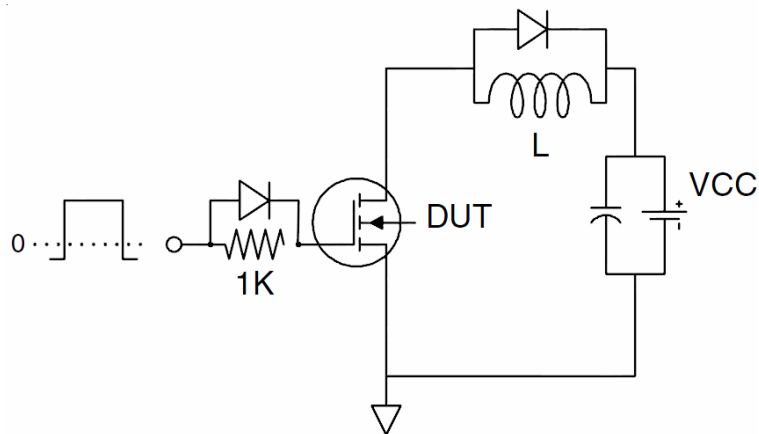

3) Switch Time Test Circuit

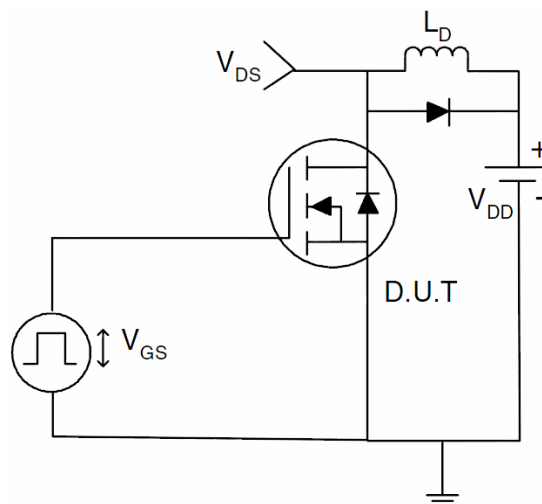



Typical Electrical and Thermal Characteristics (Curves)

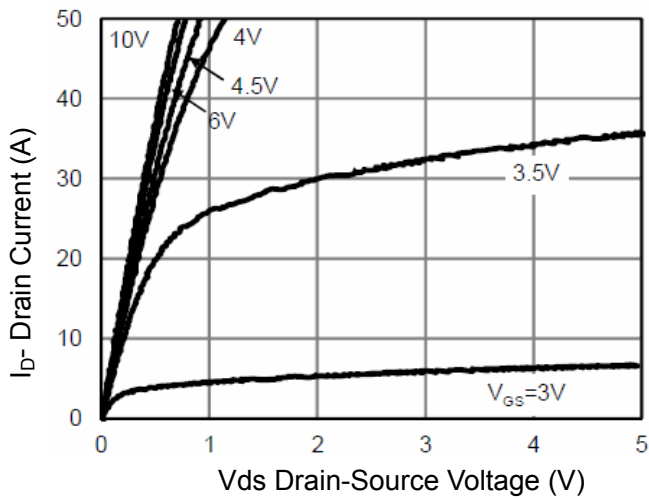

Figure 1 Output Characteristics

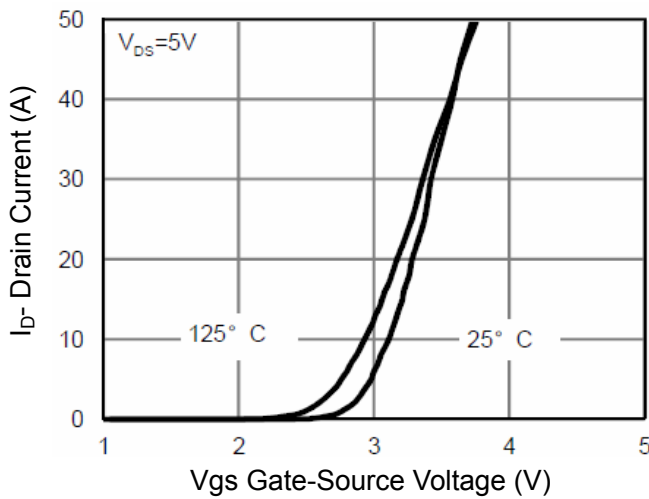

Figure 2 Transfer Characteristics

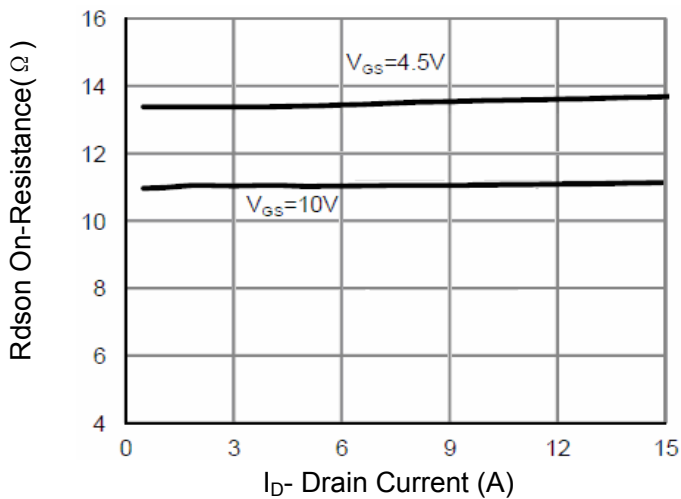

Figure 3 Rdson- Drain Current

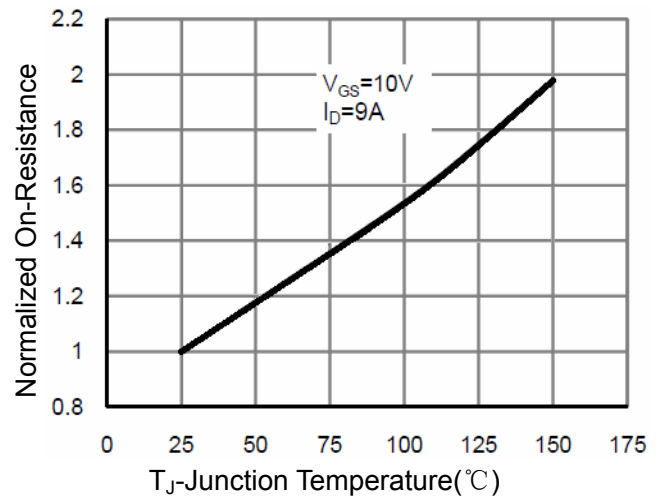

Figure 4 Rdson-Junction Temperature

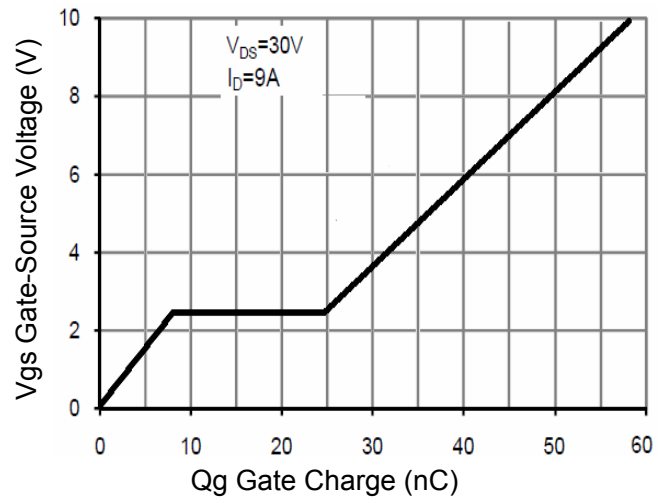

Figure 5 Gate Charge

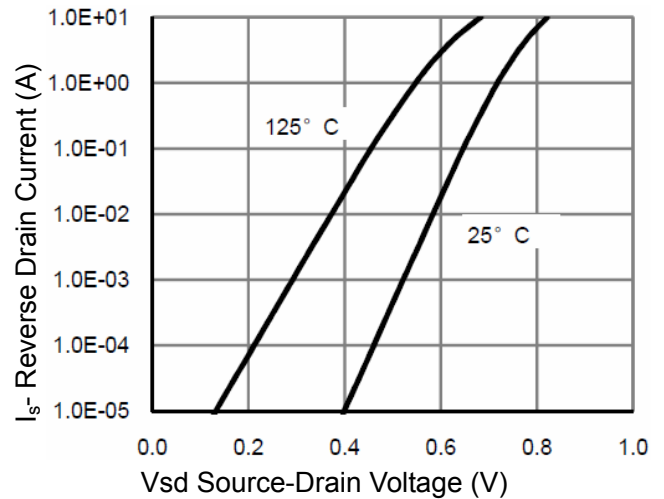

Figure 6 Source- Drain Diode Forward

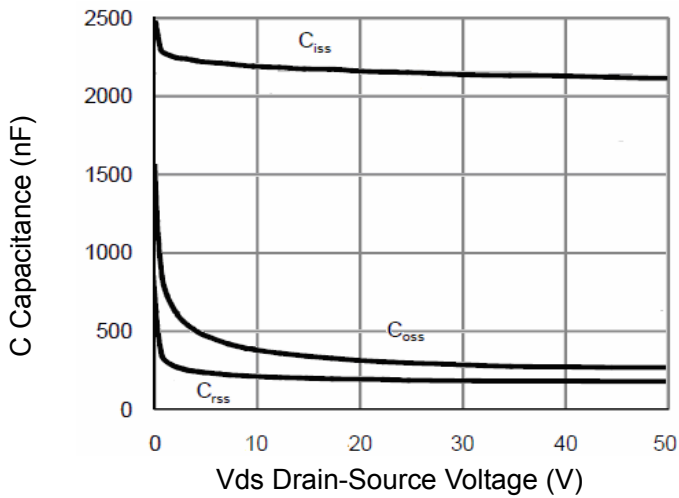

Figure 7 Capacitance vs Vds

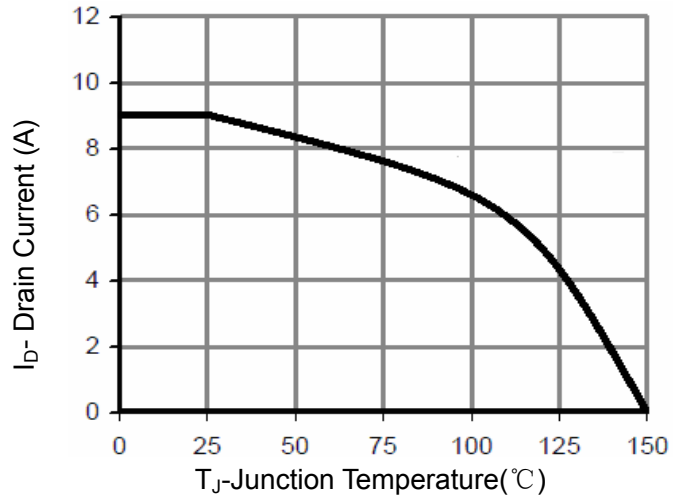

Figure 9 Current De-rating

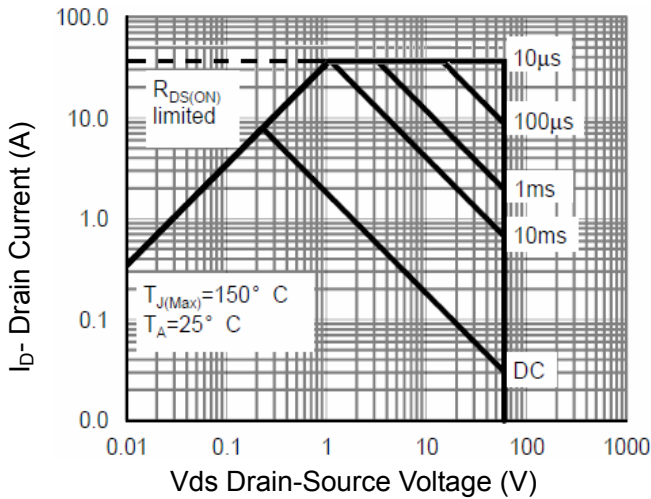

Figure 8 Safe Operation Area

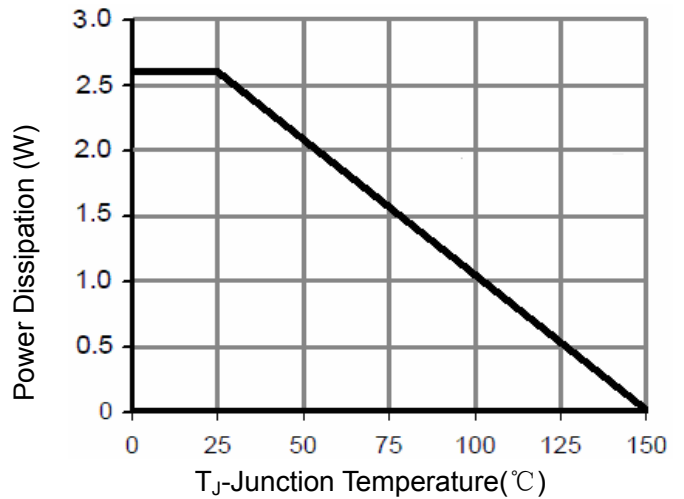

Figure 10 Power De-rating

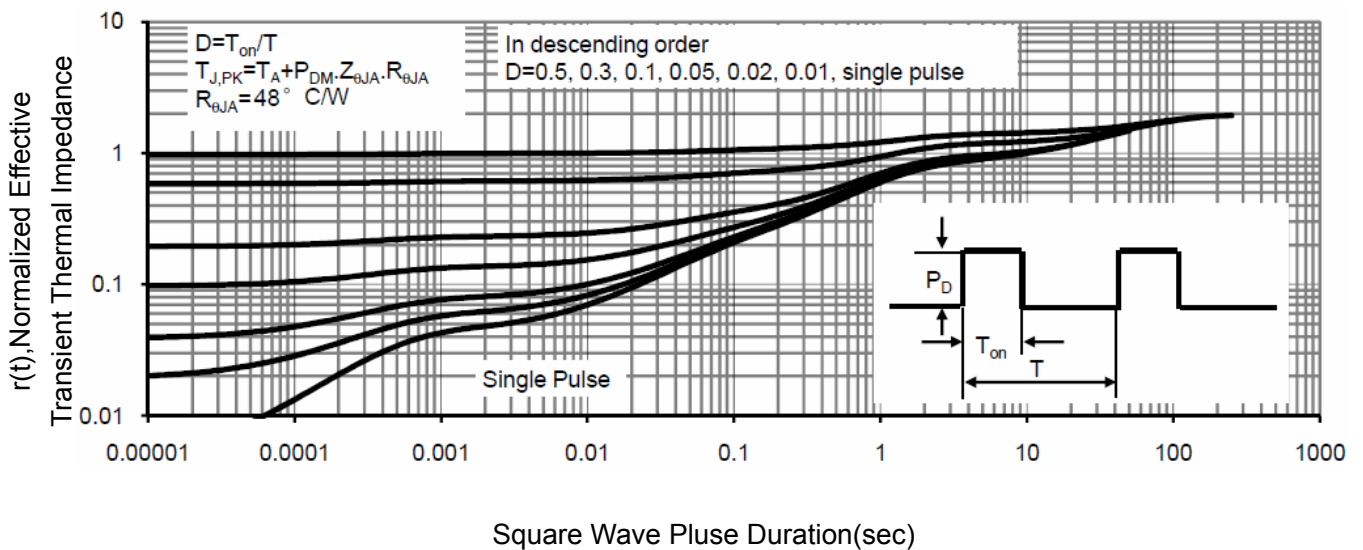
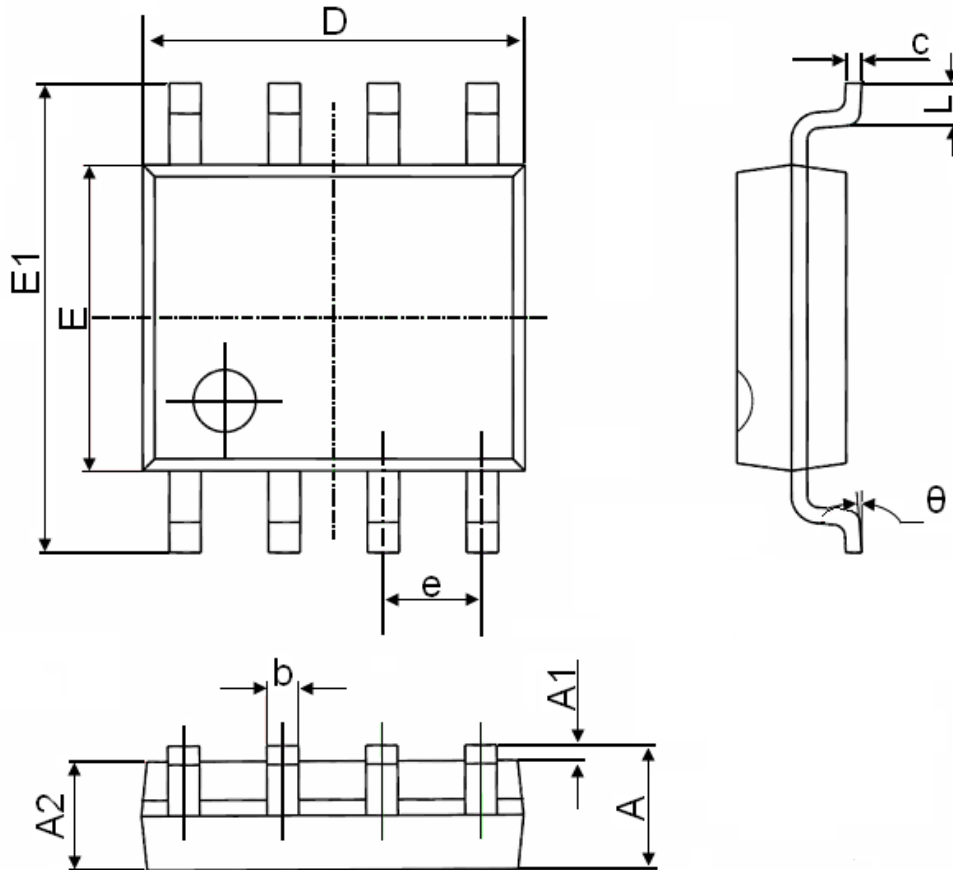

Figure 11 Normalized Maximum Transient Thermal Impedance



SOP-8 Package Information



Symbol	Dimensions In Millimeters		Dimensions In Inches	
	Min.	Max.	Min.	Max.
A	1.350	1.750	0.053	0.069
A1	0.100	0.250	0.004	0.010
A2	1.350	1.550	0.053	0.061
b	0.330	0.510	0.013	0.020
c	0.170	0.250	0.006	0.010
D	4.700	5.100	0.185	0.200
E	3.800	4.000	0.150	0.157
E1	5.800	6.200	0.228	0.244
e	1.270(BSC)		0.050(BSC)	
L	0.400	1.270	0.016	0.050
θ	0°	8°	0°	8°