

TGD N-Channel Enhancement Mode Power MOSFET

Description

The TGD6007AS uses advanced trench technology and design to provide excellent $R_{DS(ON)}$ with low gate charge. It can be used in a wide variety of applications.

General Features

- $V_{DS} = 60V, I_D = 7A$
- $R_{DS(ON)} < 30m\Omega @ V_{GS}=10V$ (Typ: 22m Ω)
- $R_{DS(ON)} < 35m\Omega @ V_{GS}=4.5V$ (Typ: 27m Ω)
- High density cell design for ultra low Rdson
- Fully characterized avalanche voltage and current
- Low gate to drain charge to reduce switching losses

Application

- Power switching application
- Hard switched and high frequency circuits
- Uninterruptible power supply

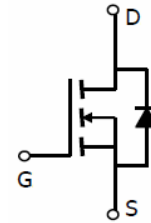

Schematic diagram

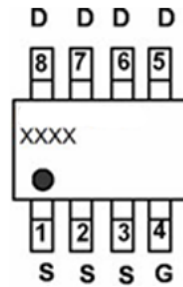

pin assignment

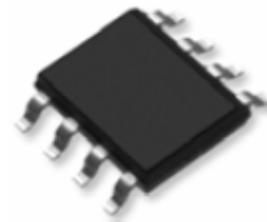

SOP-8 top view

Package Marking and Ordering Information

Device Marking	Device	Device Package	Reel Size	Tape width	Quantity
TGD6007AS	TGD6007AS	SOP-8	Ø330mm	12mm	2500 units

Absolute Maximum Ratings ($T_A=25^\circ C$ unless otherwise noted)

Parameter	Symbol	Limit	Unit
Drain-Source Voltage	V_{DS}	60	V
Gate-Source Voltage	V_{GS}	±20	V
Drain Current-Continuous	I_D	7	A
Drain Current-Continuous($T_C=100^\circ C$)	$I_D(100^\circ C)$	5	A
Pulsed Drain Current	I_{DM}	40	A
Maximum Power Dissipation	P_D	2.1	W
Operating Junction and Storage Temperature Range	T_J, T_{STG}	-55 To 150	°C

Thermal Characteristic

Thermal Resistance, Junction-to-Ambient ^(Note 2)	$R_{\theta JA}$	60	°C/W
---	-----------------	----	------



Electrical Characteristics (T_A=25°C unless otherwise noted)

Parameter	Symbol	Condition	Min	Typ	Max	Unit
Off Characteristics						
Drain-Source Breakdown Voltage	BV _{DSS}	V _{GS} =0V, I _D =250μA	60	69	-	V
Zero Gate Voltage Drain Current	I _{DSS}	V _{DS} =60V, V _{GS} =0V	-	-	1	μA
Gate-Body Leakage Current	I _{GSS}	V _{GS} =±20V, V _{DS} =0V	-	-	±100	nA
On Characteristics (Note 3)						
Gate Threshold Voltage	V _{GS(th)}	V _{DS} =V _{GS} , I _D =250μA	1.0	1.4	2.0	V
Drain-Source On-State Resistance	R _{DS(ON)}	V _{GS} =10V, I _D =7A		22	30	mΩ
		V _{GS} =4.5V, I _D =6A		27	35	mΩ
Forward Transconductance	g _{FS}	V _{DS} =5V, I _D =7A		20	-	S
Dynamic Characteristics (Note 4)						
Input Capacitance	C _{ISS}	V _{DS} =25V, V _{GS} =0V, F=1.0MHz		1920		PF
Output Capacitance	C _{OSS}			155		PF
Reverse Transfer Capacitance	C _{RSS}			116		PF
Switching Characteristics (Note 4)						
Turn-on Delay Time	t _{d(on)}	V _{DS} =30V, R _L =4.7Ω V _{GS} =10V, R _{GEN} =3Ω	-	8	-	nS
Turn-on Rise Time	t _r		-	5	-	nS
Turn-Off Delay Time	t _{d(off)}		-	29	-	nS
Turn-Off Fall Time	t _f		-	6	-	nS
Total Gate Charge	Q _g	V _{DS} =30V, I _D =7A, V _{GS} =10V	-	50	-	nC
Gate-Source Charge	Q _{gs}		-	8	-	nC
Gate-Drain Charge	Q _{gd}		-	16	-	nC
Drain-Source Diode Characteristics						
Diode Forward Voltage (Note 3)	V _{SD}	V _{GS} =0V, I _S =7A	-	-	1.2	V
Diode Forward Current (Note 2)	I _S		-	-	7	A
Reverse Recovery Time	t _{rr}	T _J = 25°C, I _F =7A di/dt = 100A/μs (Note 3)	-	35	-	nS
Reverse Recovery Charge	Q _{rr}		-	43	-	nC
Forward Turn-On Time	t _{on}	Intrinsic turn-on time is negligible (turn-on is dominated by LS+LD)				

Notes:

1. Repetitive Rating: Pulse width limited by maximum junction temperature.
2. Surface Mounted on FR4 Board, t ≤ 10 sec.
3. Pulse Test: Pulse Width ≤ 300μs, Duty Cycle ≤ 2%.
4. Guaranteed by design, not subject to production

Test Circuit

1) E_{AS} test Circuits

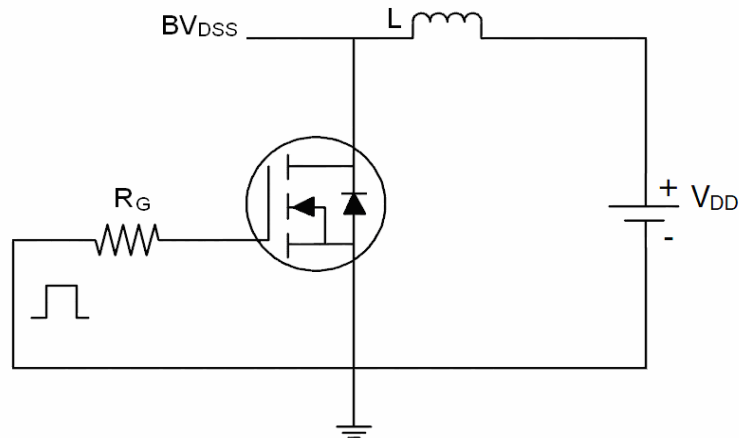

2) Gate charge test Circuit

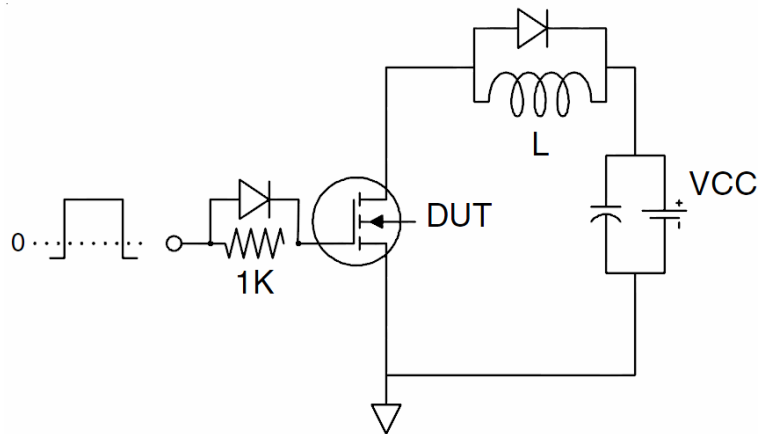

3) Switch Time Test Circuit

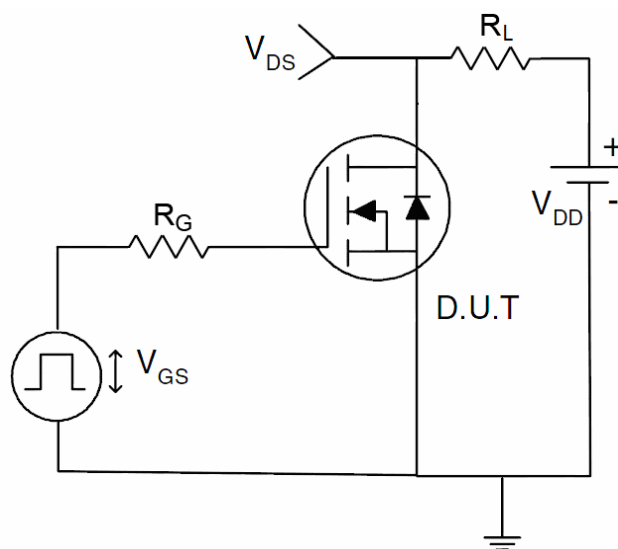



Typical Electrical and Thermal Characteristics (Curves)

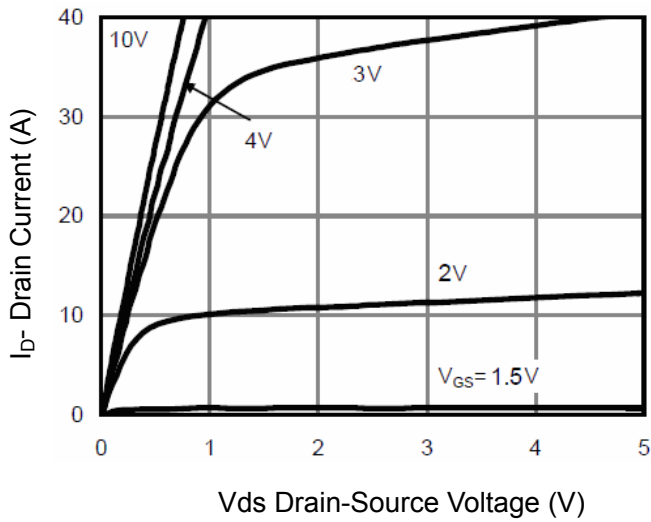

Figure 1 Output Characteristics

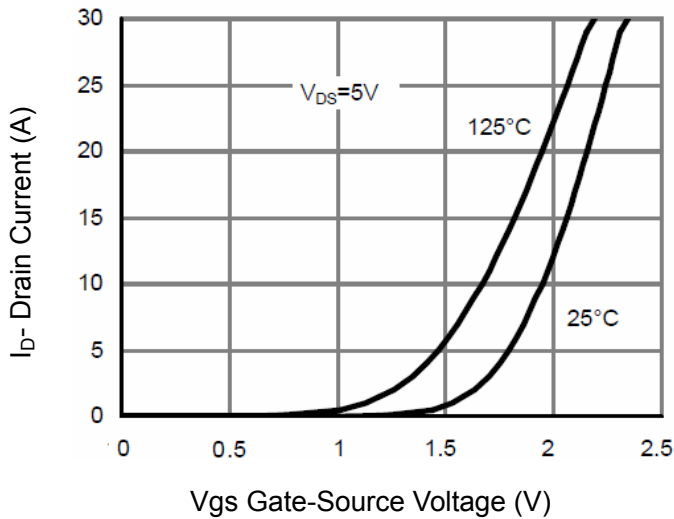

Figure 2 Transfer Characteristics

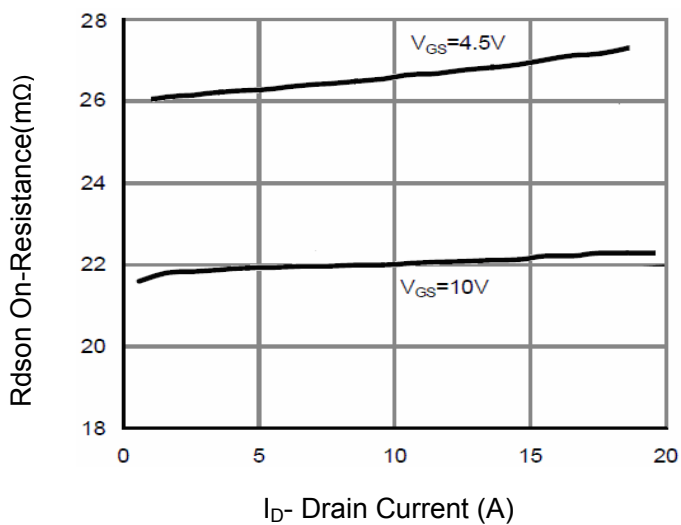

Figure 3 Rdson- Drain Current

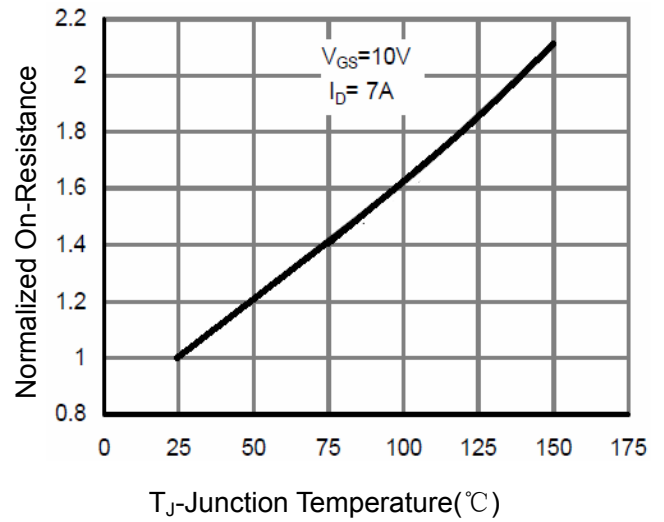

Figure 4 Rdson-Junction Temperature

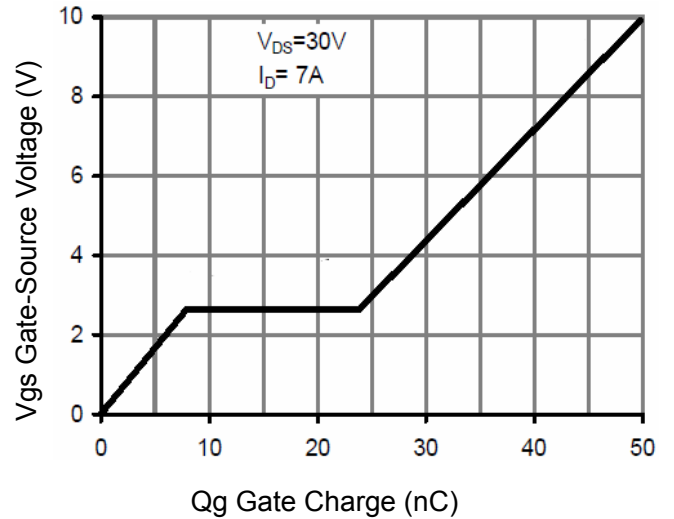

Figure 5 Gate Charge

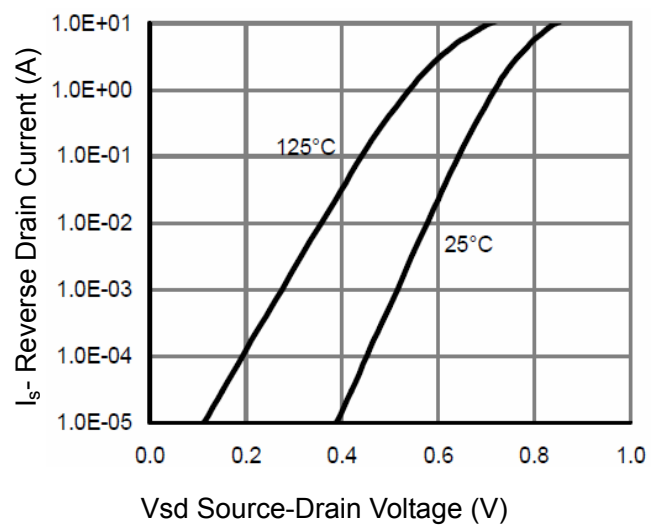
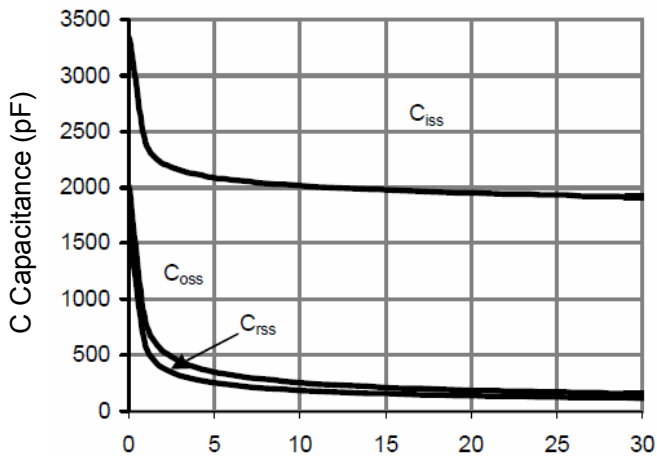
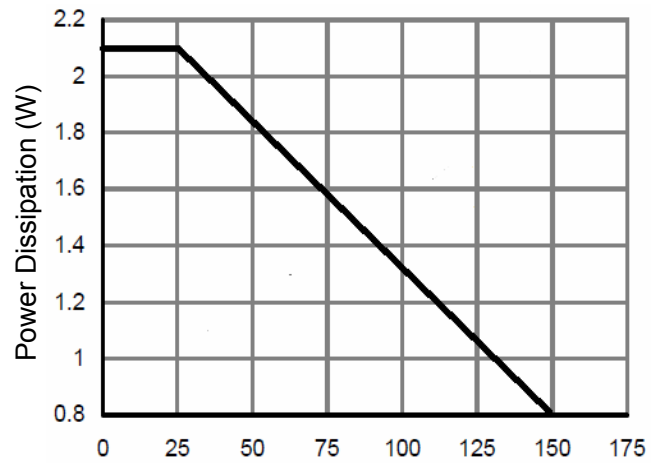

Figure 6 Source- Drain Diode Forward



Vds Drain-Source Voltage (V)
Figure 7 Capacitance vs Vds



T_J-Junction Temperature(°C)
Figure 9 Power De-rating

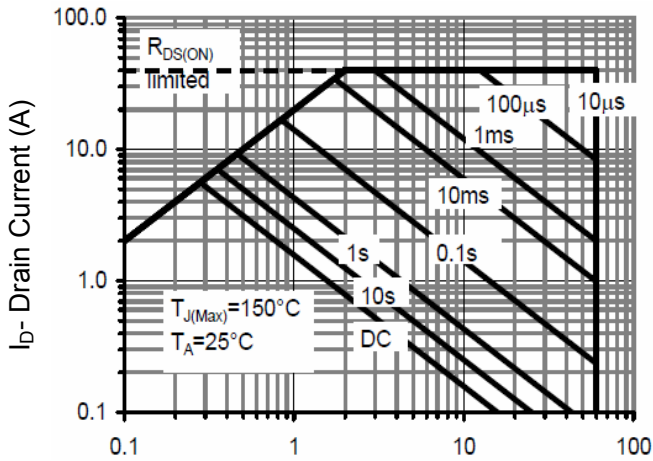

Vds Drain-Source Voltage (V)
Figure 8 Safe Operation Area

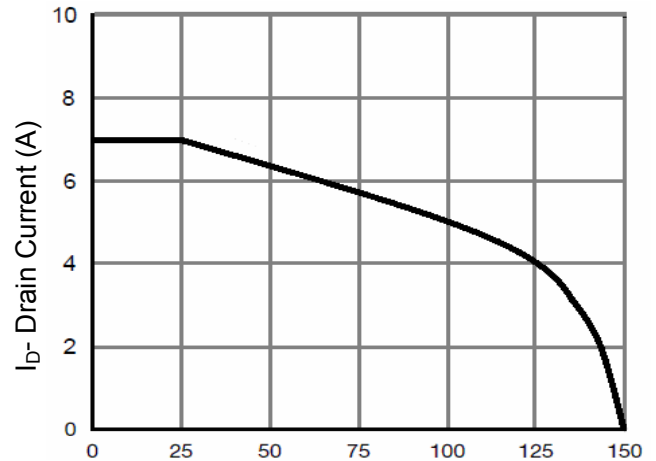

T_J-Junction Temperature(°C)
Figure 10 Current De-rating

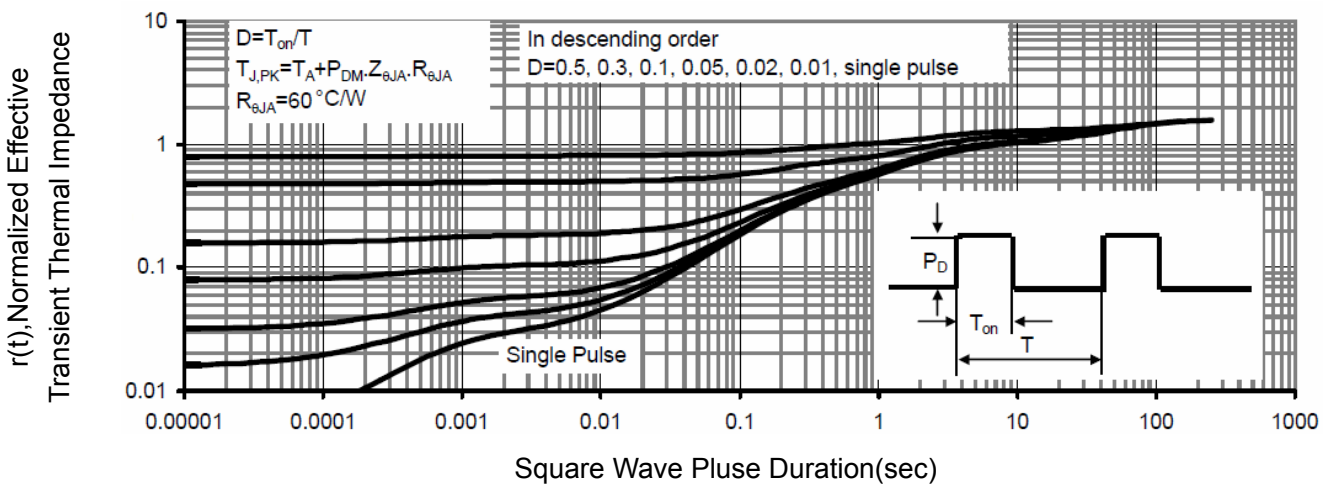
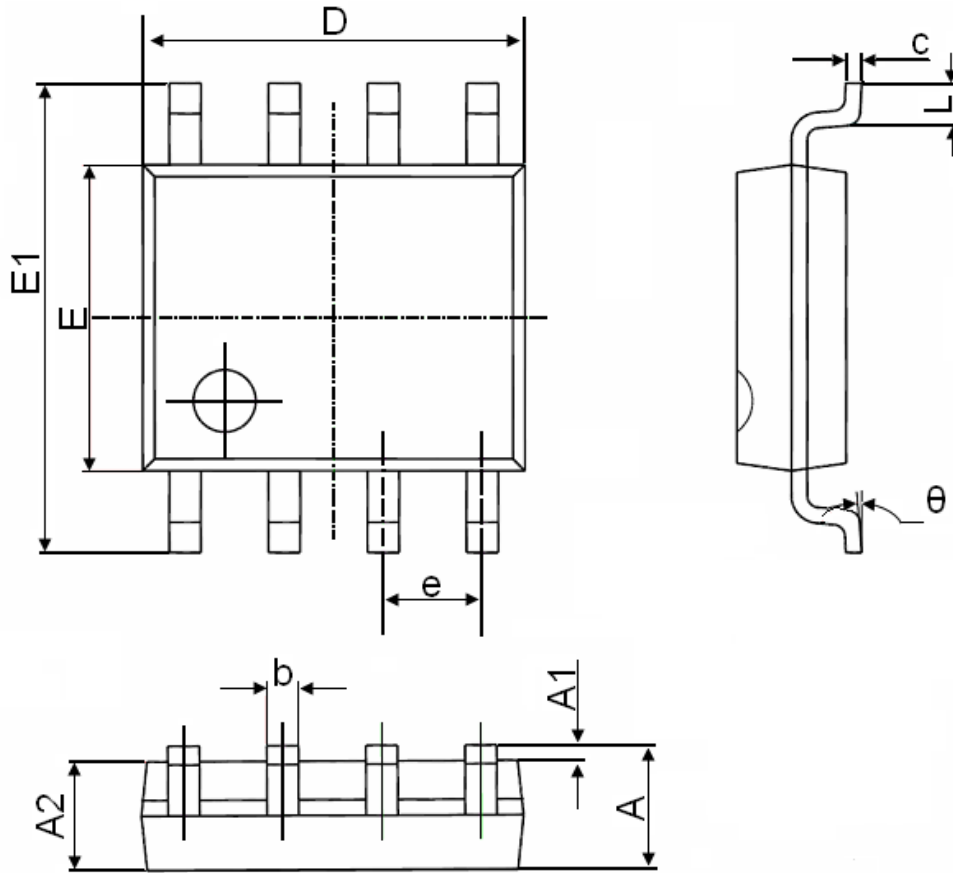

Figure 11 Normalized Maximum Transient Thermal Impedance



SOP-8 Package Information



Symbol	Dimensions In Millimeters		Dimensions In Inches	
	Min.	Max.	Min.	Max.
A	1.350	1.750	0.053	0.069
A1	0.100	0.250	0.004	0.010
A2	1.350	1.550	0.053	0.061
b	0.330	0.510	0.013	0.020
c	0.170	0.250	0.006	0.010
D	4.700	5.100	0.185	0.200
E	3.800	4.000	0.150	0.157
E1	5.800	6.200	0.228	0.244
e	1.270(BSC)		0.050(BSC)	
L	0.400	1.270	0.016	0.050
θ	0°	8°	0°	8°