

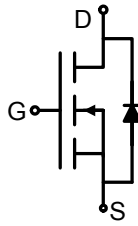
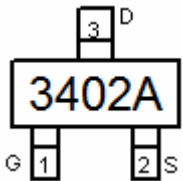

TGD N-Channel Enhancement Mode Power MOSFET

<p>Description The TGD3402A uses advanced trench technology to provide excellent $R_{DS(ON)}$, low gate charge and operation with gate voltages as low as 2.5V. This device is suitable for use as a Battery protection or in other Switching application.</p> <p>General Features</p> <ul style="list-style-type: none"> ● $V_{DS} = 30V, I_D = 3A$ ● $R_{DS(ON)} < 85m\Omega @ V_{GS}=2.5V$ ● $R_{DS(ON)} < 70m\Omega @ V_{GS}=4.5V$ ● High power and current handling capability ● Lead free product is acquired ● Surface mount package <p>Application</p> <ul style="list-style-type: none"> ● Battery protection ● Load switch ● Power management 	<div style="text-align: center;">  <p>Schematic diagram</p>  <p>pin assignment</p>  <p>SOT-23 top view</p> </div>
---	---

Package Marking and Ordering Information

Device Marking	Device	Device Package	Reel Size	Tape width	Quantity
3402A	TGD3402A	SOT-23	Ø180mm	8 mm	3000 units

Absolute Maximum Ratings ($T_A=25^\circ C$ unless otherwise noted)

Parameter	Symbol	Limit	Unit
Drain-Source Voltage	V_{DS}	30	V
Gate-Source Voltage	V_{GS}	± 12	V
Drain Current-Continuous	I_D	3	A
Drain Current-Pulsed ^(Note 1)	I_{DM}	20	A
Maximum Power Dissipation	P_D	0.9	W
Operating Junction and Storage Temperature Range	T_J, T_{STG}	-55 To 150	$^\circ C$

Thermal Characteristic

Thermal Resistance, Junction-to-Ambient ^(Note 2)	$R_{\theta JA}$	138	$^\circ C/W$
---	-----------------	-----	--------------

Electrical Characteristics ($T_A=25^\circ C$ unless otherwise noted)

Parameter	Symbol	Condition	Min	Typ	Max	Unit
Off Characteristics						
Drain-Source Breakdown Voltage	BV_{DSS}	$V_{GS}=0V, I_D=250\mu A$	30	-	-	V
Zero Gate Voltage Drain Current	I_{DSS}	$V_{DS}=20V, V_{GS}=0V$	-	-	1	μA



Parameter	Symbol	Condition	Min	Typ	Max	Unit
Gate-Body Leakage Current	I_{GSS}	$V_{GS}=\pm 12V, V_{DS}=0V$	-	-	± 100	nA
On Characteristics (Note 3)						
Gate Threshold Voltage	$V_{GS(th)}$	$V_{DS}=V_{GS}, I_D=250\mu A$	0.6	0.85	1.4	V
Drain-Source On-State Resistance	$R_{DS(on)}$	$V_{GS}=10V, I_D=3A$	-	50	60	m Ω
		$V_{GS}=4.5V, I_D=3A$	-	55	70	m Ω
		$V_{GS}=2.5V, I_D=2A$	-	68	85	m Ω
Forward Transconductance	g_{FS}	$V_{DS}=5V, I_D=3A$	14	-	-	S
Dynamic Characteristics (Note 4)						
Input Capacitance	C_{iss}	$V_{DS}=10V, V_{GS}=0V,$ $F=1.0MHz$	-	235	-	PF
Output Capacitance	C_{oss}		-	35	-	PF
Reverse Transfer Capacitance	C_{rss}		-	18	-	PF
Switching Characteristics (Note 4)						
Turn-on Delay Time	$t_{d(on)}$	$V_{DD}=15V, I_D=1A$ $V_{GS}=4.5V, R_{GEN}=6\Omega$	-	3.5	-	nS
Turn-on Rise Time	t_r		-	1.5	-	nS
Turn-Off Delay Time	$t_{d(off)}$		-	17.5	-	nS
Turn-Off Fall Time	t_f		-	2.5	-	nS
Total Gate Charge	Q_g	$V_{DS}=15V, I_D=3A, V_{GS}=4.5V$	-	4.7	-	nC
Gate-Source Charge	Q_{gs}		-	0.95	-	nC
Gate-Drain Charge	Q_{gd}		-	1.6	-	nC
Drain-Source Diode Characteristics						
Diode Forward Voltage (Note 3)	V_{SD}	$V_{GS}=0V, I_S=3A$	-	-	1.2	V
Diode Forward Current (Note 2)	I_S		-	-	3	A

Notes:

1. Repetitive Rating: Pulse width limited by maximum junction temperature.
2. Surface Mounted on FR4 Board, $t \leq 10$ sec.
3. Pulse Test: Pulse Width $\leq 300\mu s$, Duty Cycle $\leq 2\%$.
4. Guaranteed by design, not subject to production

Typical Electrical and Thermal Characteristics

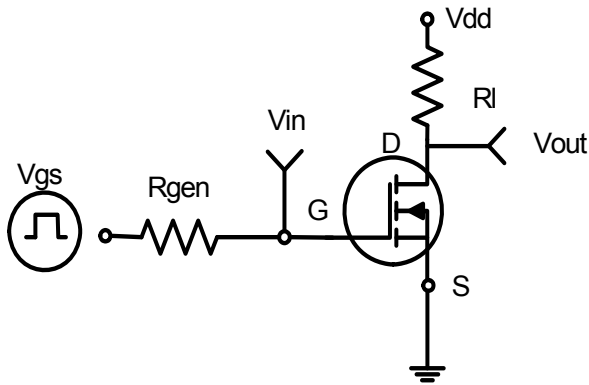

Figure 1: Switching Test Circuit

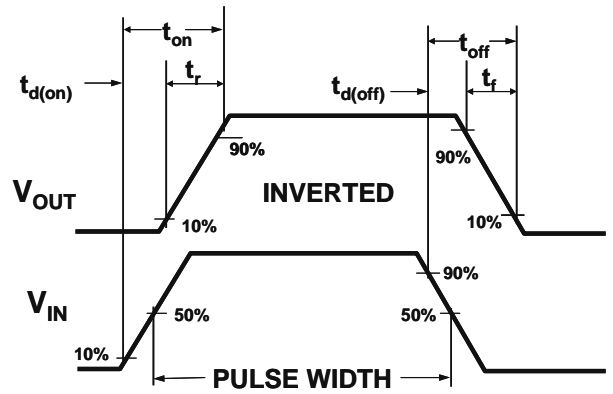

Figure 2: Switching Waveforms

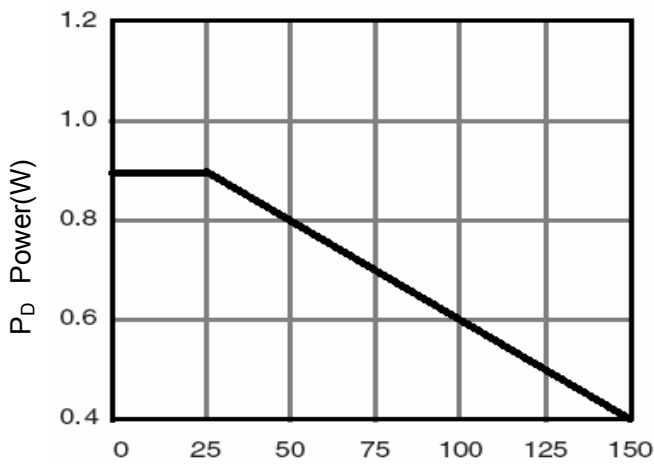

Figure 3 Power Dissipation

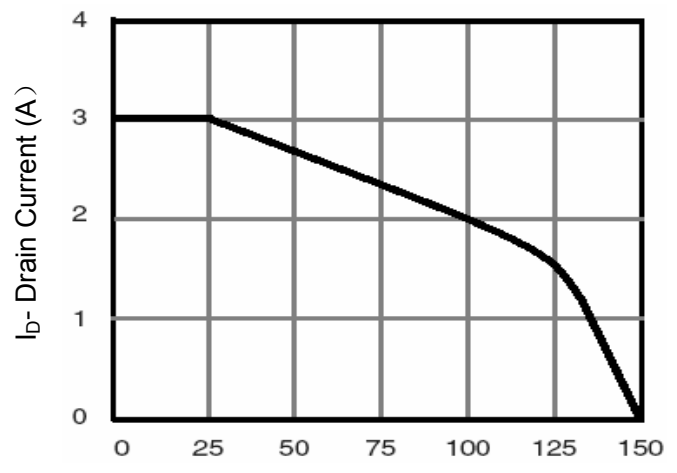

Figure 4 Drain Current

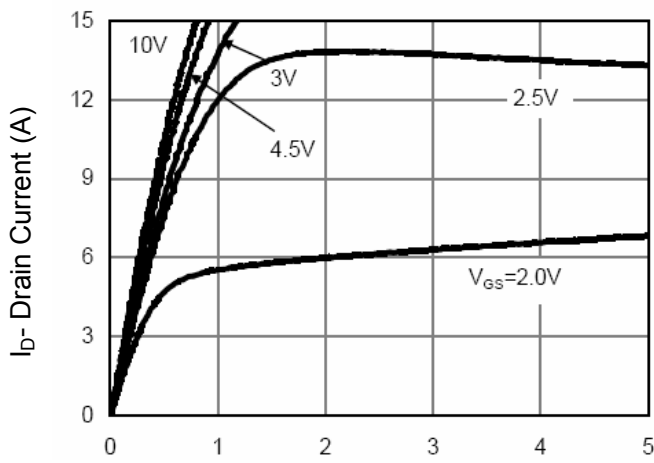

Figure 5 Output Characteristics

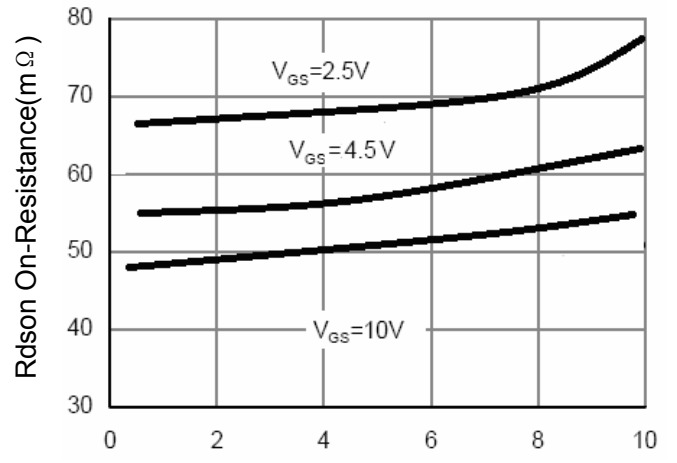

Figure 6 Drain-Source On-Resistance

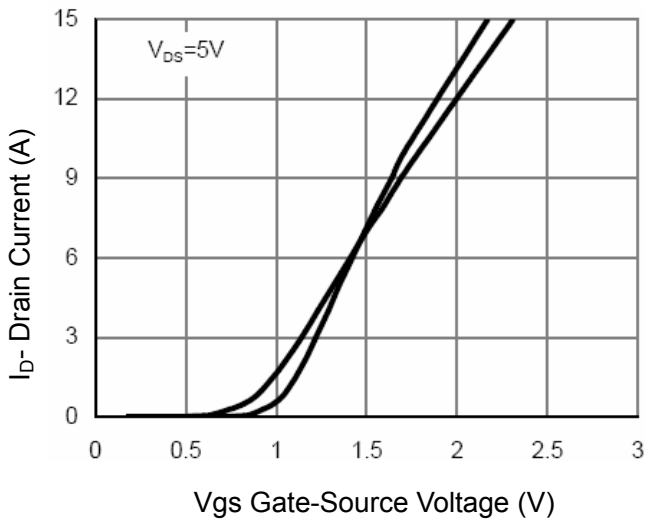

Figure 7 Transfer Characteristics

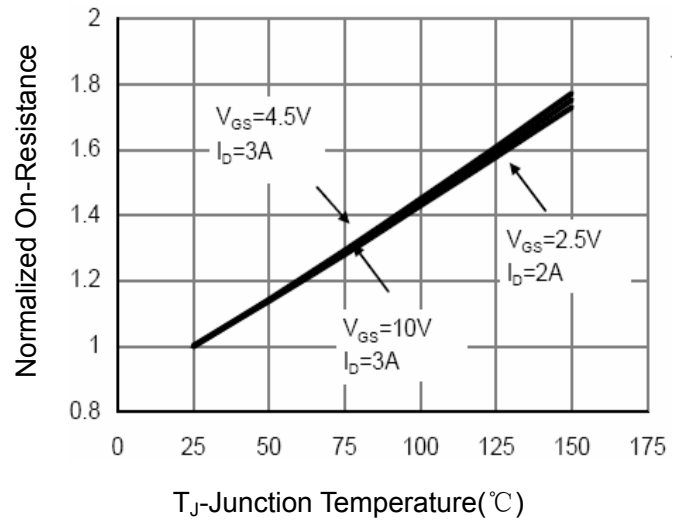

Figure 8 Drain-Source On-Resistance

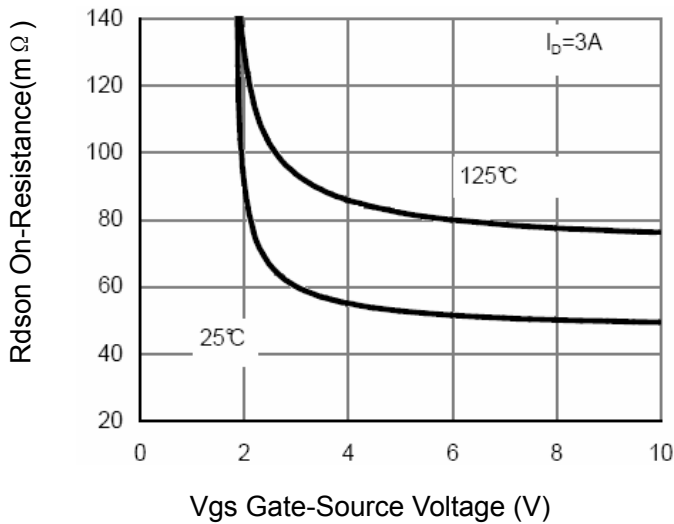

Figure 9 Rdson vs Vgs

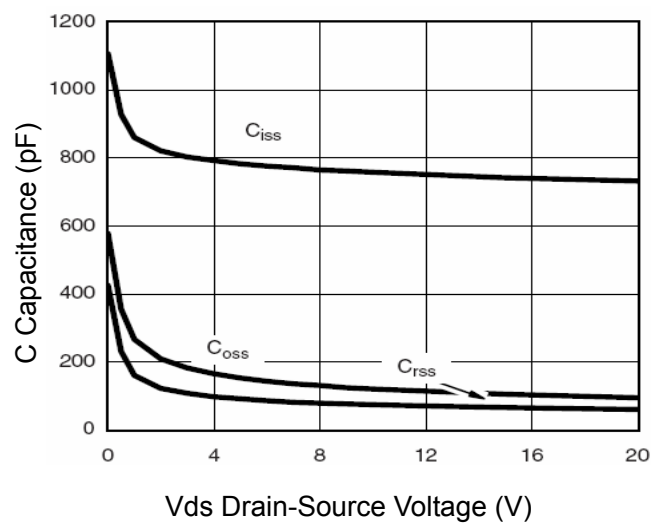

Figure 10 Capacitance vs Vds

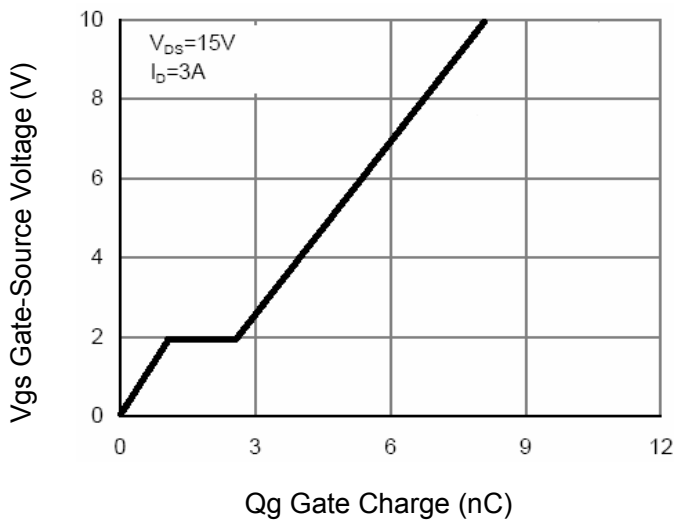

Figure 11 Gate Charge

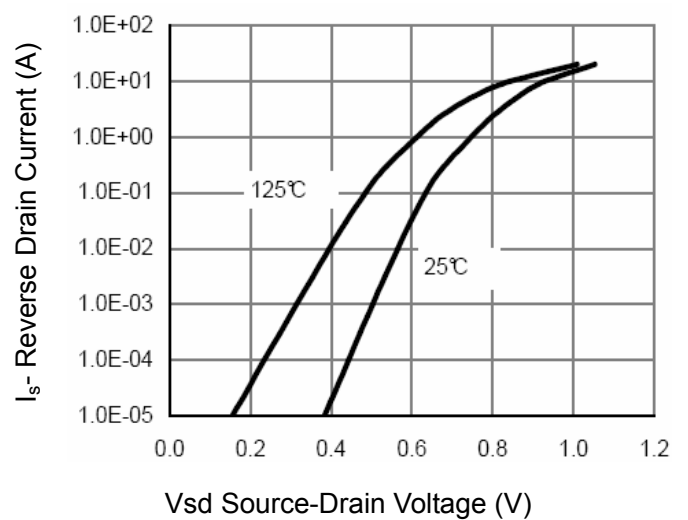

Figure 12 Source- Drain Diode Forward

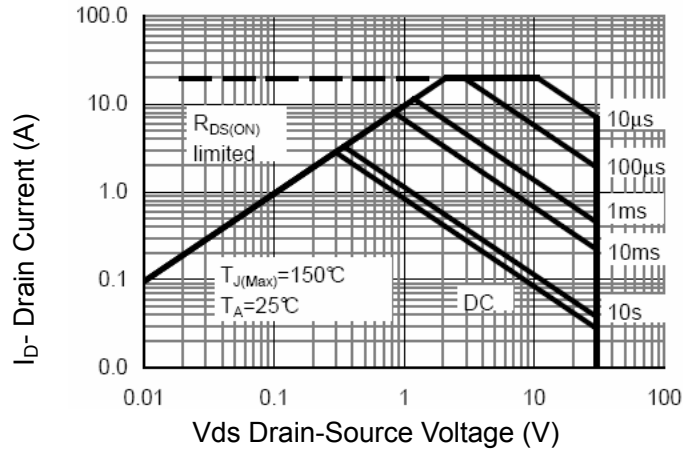

Figure 13 Safe Operation Area

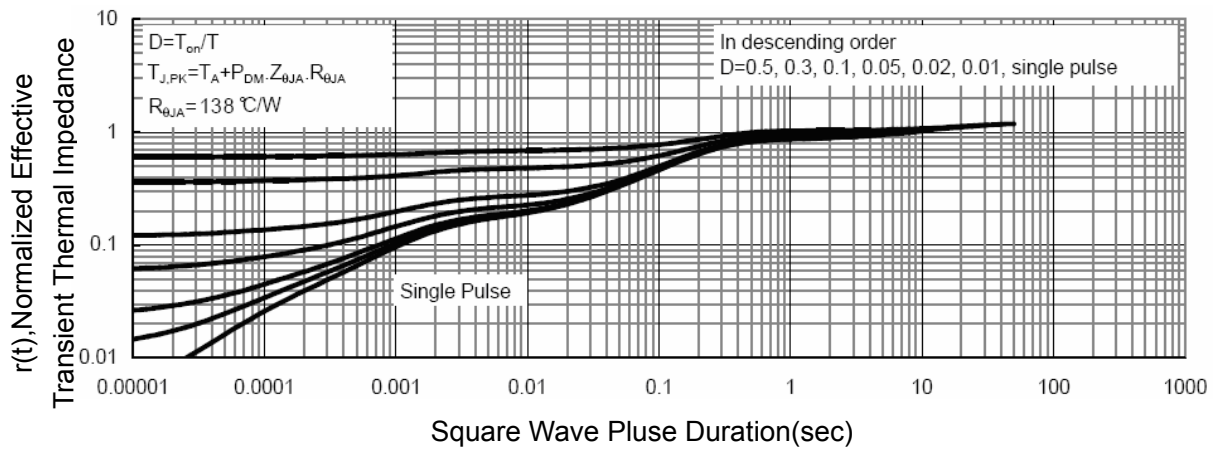
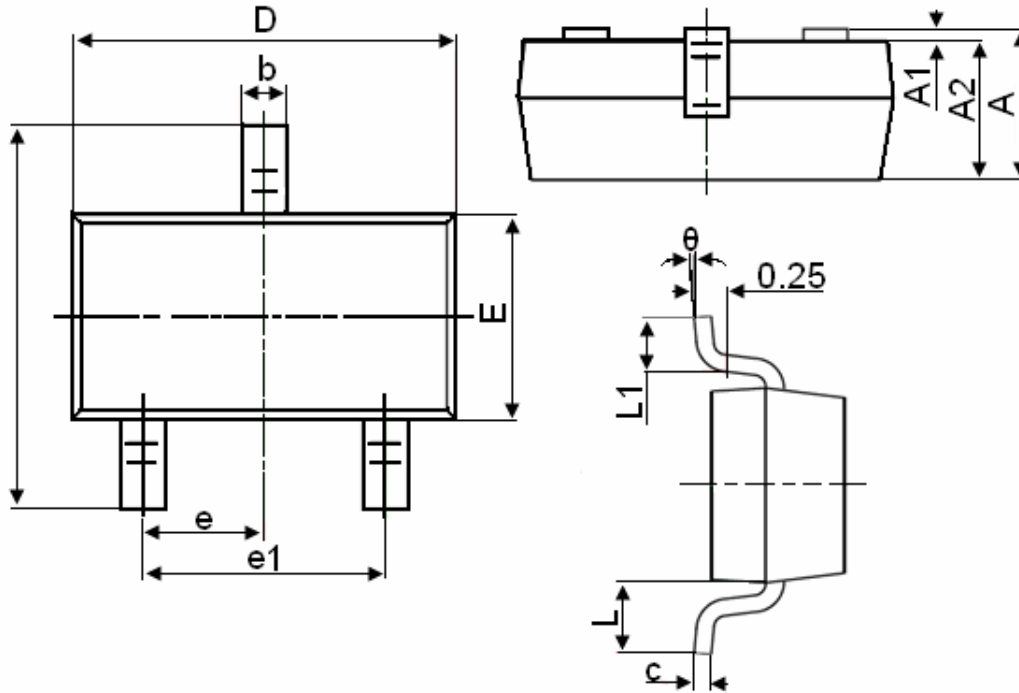

Figure 14 Normalized Maximum Transient Thermal Impedance



SOT-23 Package Information



Symbol	Dimensions in Millimeters	
	MIN.	MAX.
A	0.900	1.150
A1	0.000	0.100
A2	0.900	1.050
b	0.300	0.500
c	0.080	0.150
D	2.800	3.000
E	1.200	1.400
E1	2.250	2.550
e	0.950TYP	
e1	1.800	2.000
L	0.550REF	
L1	0.300	0.500
θ	0°	8°

Notes

1. All dimensions are in millimeters.
2. Tolerance ±0.10mm (4 mil) unless otherwise specified
3. Package body sizes exclude mold flash and gate burrs. Mold flash at the non-lead sides should be less than 5 mils.
4. Dimension L is measured in gauge plane.
5. Controlling dimension is millimeter, converted inch dimensions are not necessarily exact.