

TGD N-Channel Enhancement Mode Power MOSFET

Description

The TGD0115K uses advanced trench technology and design to provide excellent $R_{DS(ON)}$ with low gate charge. It can be used in a wide variety of applications.

General Features

- $V_{DS} = 100V, I_D = 15A$
 $R_{DS(ON)} < 90m\Omega @ V_{GS} = 10V$ (Typ:75m Ω)
 $R_{DS(ON)} < 100m\Omega @ V_{GS} = 4.5V$ (Typ:80m Ω)
- High density cell design for ultra low R_{dson}
- Fully characterized avalanche voltage and current
- Good stability and uniformity with high E_{AS}
- Excellent package for good heat dissipation
- Special process technology for high ESD capability

Application

- Power switching application
- Hard switched and high frequency circuits

100% UIS TESTED!

100% ΔV_{ds} TESTED!

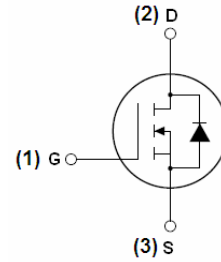

Schematic diagram

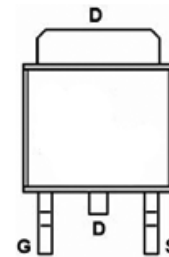

pin assignment

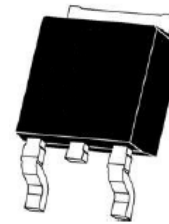

TO-252-2L top view

Package Marking and Ordering Information

Device Marking	Device	Device Package	Reel Size	Tape width	Quantity
0115K	0115K	TO-252-2L	-	-	-

Absolute Maximum Ratings ($T_C = 25^\circ C$ unless otherwise noted)

Parameter	Symbol	Limit	Unit
Drain-Source Voltage	V_{DS}	100	V
Gate-Source Voltage	V_{GS}	± 20	V
Drain Current-Continuous	I_D	15	A
Drain Current-Continuous($T_C = 100^\circ C$)	$I_D(100^\circ C)$	10.6	A
Pulsed Drain Current	I_{DM}	60	A
Maximum Power Dissipation	P_D	50	W
Single pulse avalanche energy ^(Note 5)	E_{AS}	16	mJ
Operating Junction and Storage Temperature Range	T_J, T_{STG}	-55 To 175	$^\circ C$



Thermal Characteristic

Thermal Resistance, Junction-to-Case ^(Note 2)	$R_{\theta JC}$	3	$^{\circ}C/W$
--	-----------------	---	---------------

Electrical Characteristics ($T_C=25^{\circ}C$ unless otherwise noted)

Parameter	Symbol	Condition	Min	Typ	Max	Unit
Off Characteristics						
Drain-Source Breakdown Voltage	BV_{DSS}	$V_{GS}=0V, I_D=250\mu A$	100	110	-	V
Zero Gate Voltage Drain Current	I_{DSS}	$V_{DS}=100V, V_{GS}=0V$	-	-	1	μA
Gate-Body Leakage Current	I_{GSS}	$V_{GS}=\pm 20V, V_{DS}=0V$	-	-	± 100	nA
On Characteristics ^(Note 3)						
Gate Threshold Voltage	$V_{GS(th)}$	$V_{DS}=V_{GS}, I_D=250\mu A$	1.0	1.6	2.5	V
Drain-Source On-State Resistance	$R_{DS(on)}$	$V_{GS}=10V, I_D=10A$	-	75	90	m Ω
		$V_{GS}=4.5V, I_D=10A$	-	80	100	
Forward Transconductance	g_{FS}	$V_{DS}=5V, I_D=10A$	-	10	-	S
Dynamic Characteristics ^(Note 4)						
Input Capacitance	C_{iss}	$V_{DS}=50V, V_{GS}=0V,$ $F=1.0MHz$	-	830	-	PF
Output Capacitance	C_{oss}		-	44.2	-	PF
Reverse Transfer Capacitance	C_{rss}		-	30.1	-	PF
Switching Characteristics ^(Note 4)						
Turn-on Delay Time	$t_{d(on)}$	$V_{DD}=50V, R_L=6.4\Omega$ $V_{GS}=10V, R_G=3\Omega$	-	15	-	nS
Turn-on Rise Time	t_r		-	5	-	nS
Turn-Off Delay Time	$t_{d(off)}$		-	25	-	nS
Turn-Off Fall Time	t_f		-	7	-	nS
Total Gate Charge	Q_g	$V_{DS}=50V, I_D=10A,$ $V_{GS}=10V$	-	22.3	-	nC
Gate-Source Charge	Q_{gs}		-	2.87	-	nC
Gate-Drain Charge	Q_{gd}		-	6.14	-	nC
Drain-Source Diode Characteristics						
Diode Forward Voltage ^(Note 3)	V_{SD}	$V_{GS}=0V, I_S=15A$	-	-	1.2	V
Diode Forward Current ^(Note 2)	I_S		-	-	15	A

Notes:

1. Repetitive Rating: Pulse width limited by maximum junction temperature.
2. Surface Mounted on FR4 Board, $t \leq 10$ sec.
3. Pulse Test: Pulse Width $\leq 300\mu s$, Duty Cycle $\leq 2\%$.
4. Guaranteed by design, not subject to production
5. EAS condition: $T_j=25^{\circ}C, V_{DD}=50V, V_G=10V, L=0.5mH, R_g=25\Omega$

Test Circuit

1) E_{AS} test Circuit



2) Gate charge test Circuit



3) Switch Time Test Circuit





Typical Electrical and Thermal Characteristics (Curves)

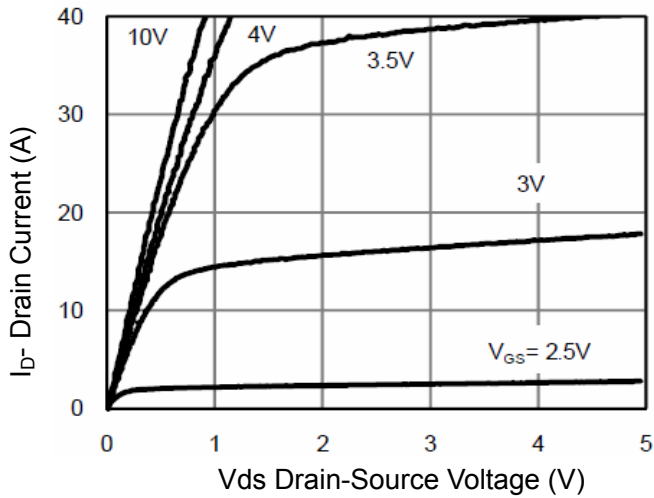

Figure 1 Output Characteristics

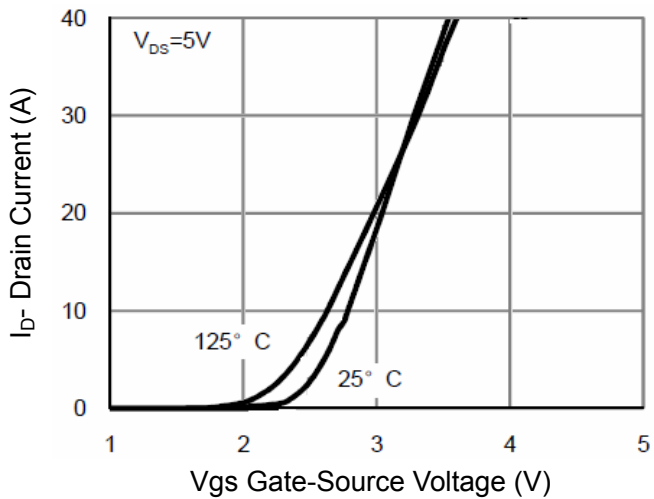

Figure 2 Transfer Characteristics

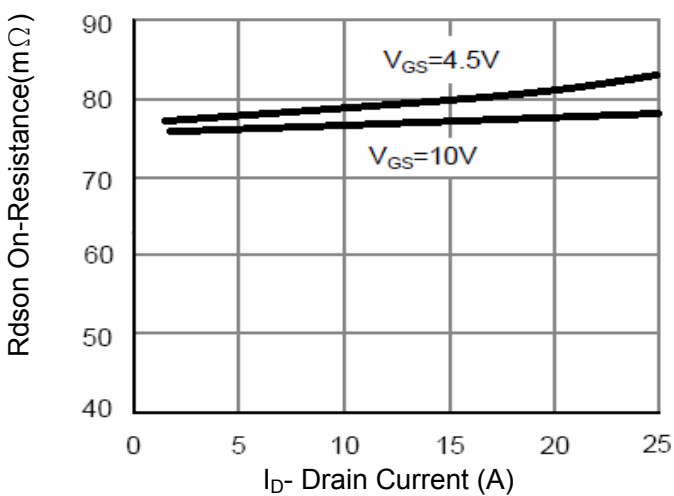

Figure 3 $R_{ds(on)}$ - Drain Current

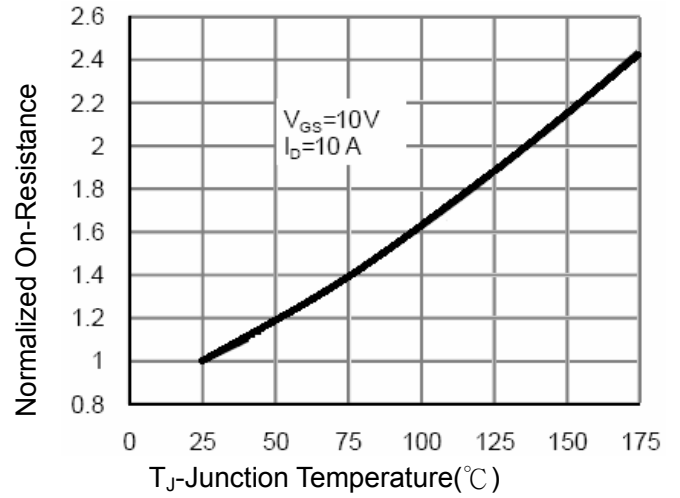

Figure 4 $R_{ds(on)}$ -Junction Temperature

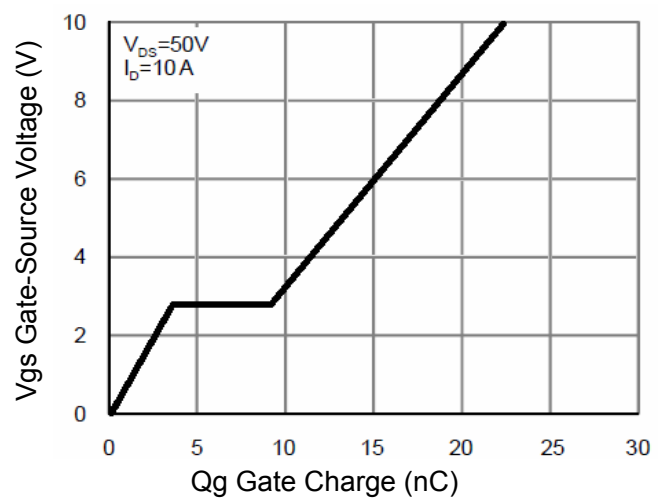

Figure 5 Gate Charge

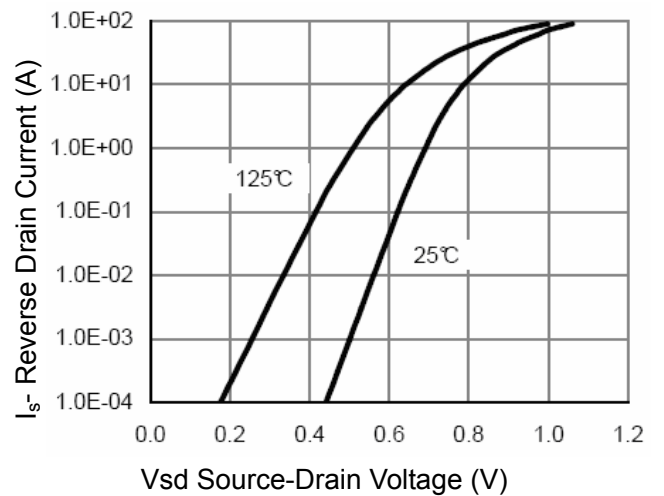

Figure 6 Source- Drain Diode Forward

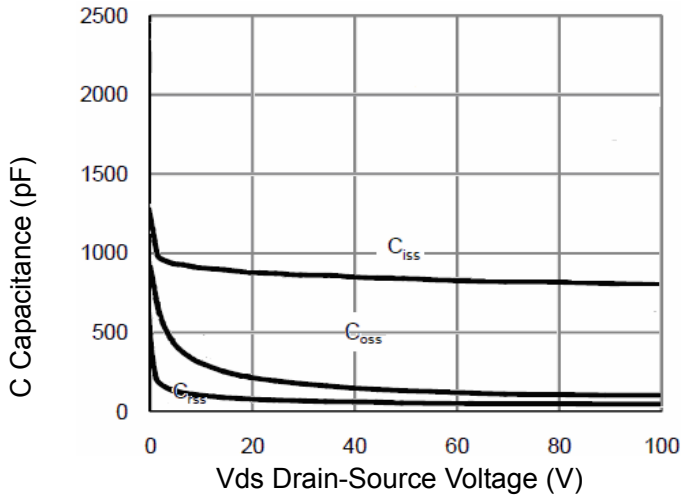

Figure 7 Capacitance vs Vds

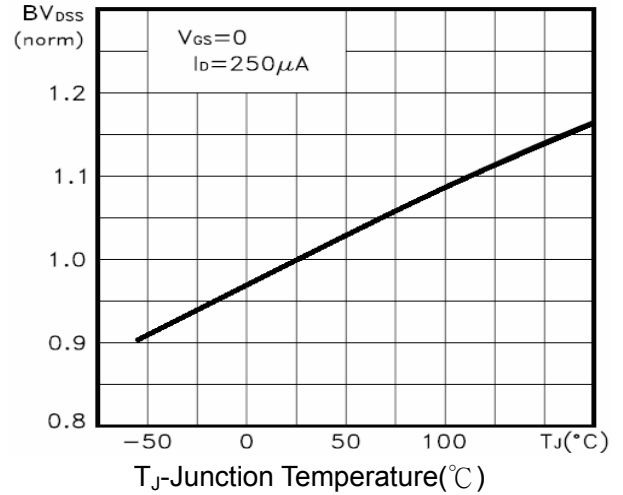

Figure 9 BV_{DSS} vs Junction Temperature

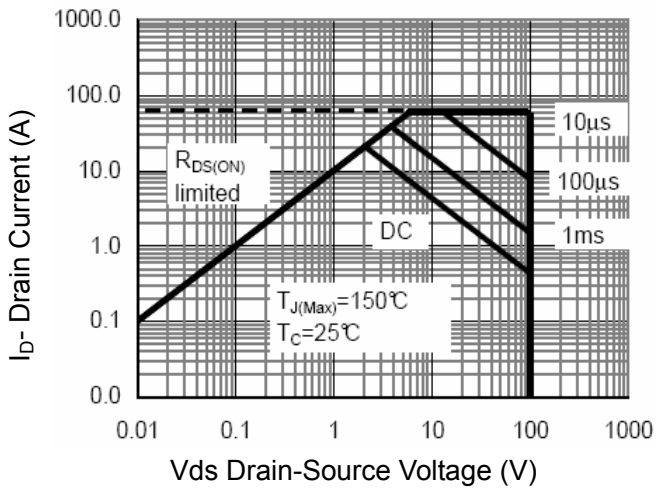

Figure 8 Safe Operation Area

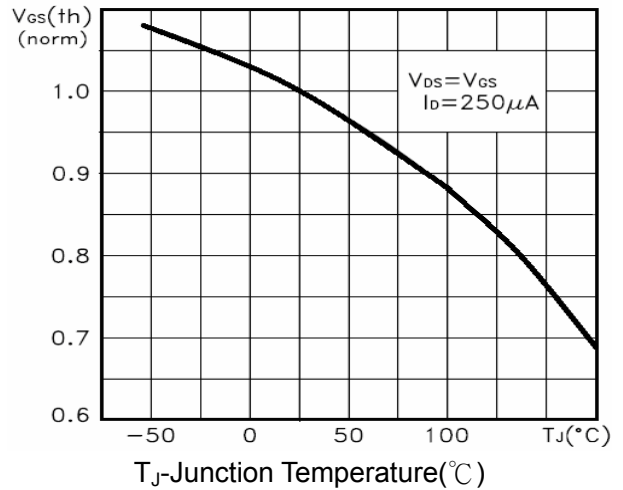

Figure 10 $V_{GS(th)}$ vs Junction Temperature

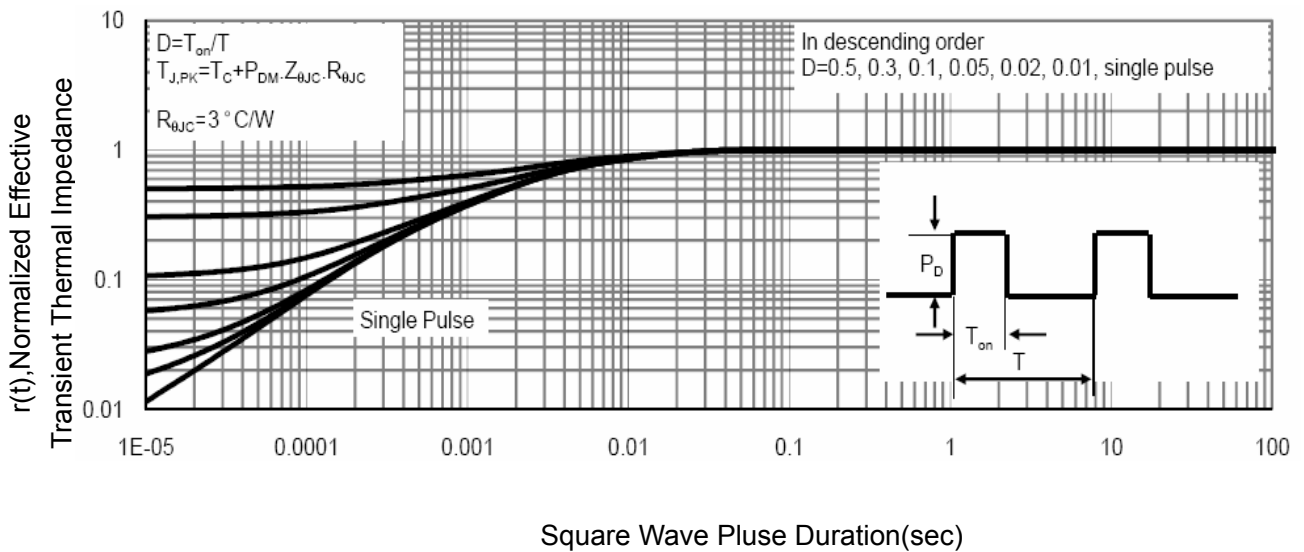
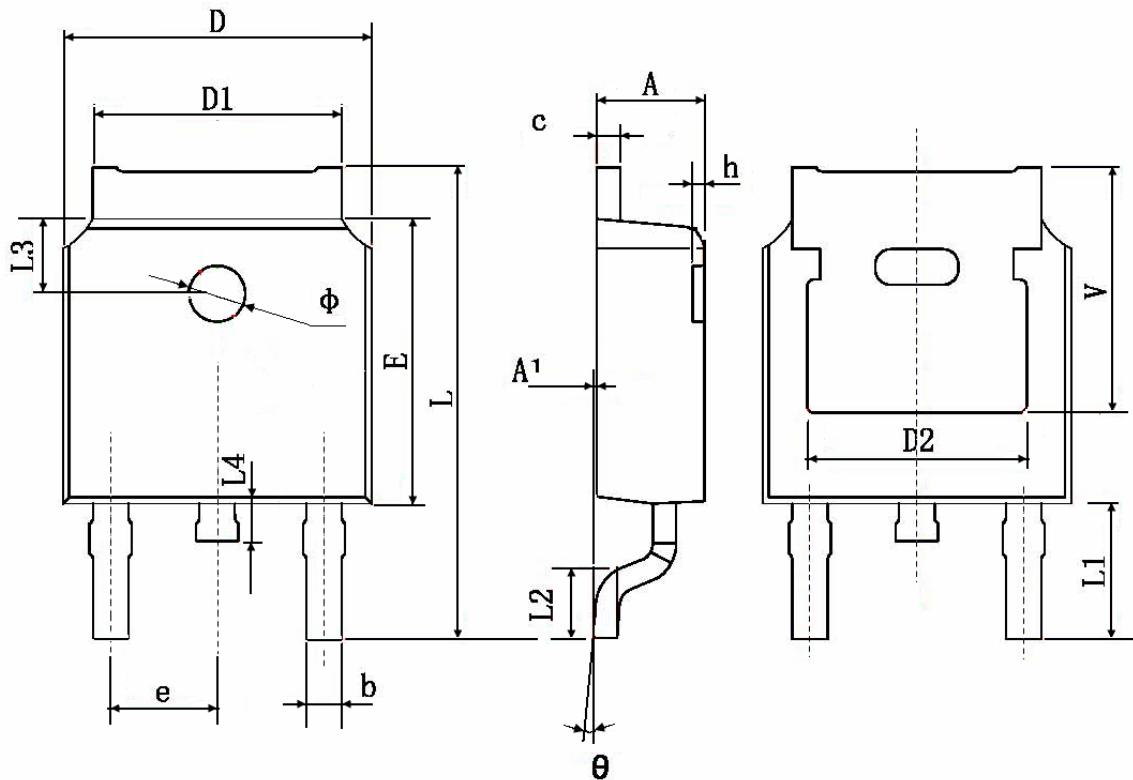

Figure 11 Normalized Maximum Transient Thermal Impedance

TO-252 Package Information



Symbol	Dimensions In Millimeters		Dimensions In Inches	
	Min.	Max.	Min.	Max.
A	2.200	2.400	0.087	0.094
A1	0.000	0.127	0.000	0.005
b	0.660	0.860	0.026	0.034
c	0.460	0.580	0.018	0.023
D	6.500	6.700	0.256	0.264
D1	5.100	5.460	0.201	0.215
D2	4.830 TYP.		0.190 TYP.	
E	6.000	6.200	0.236	0.244
e	2.186	2.386	0.086	0.094
L	9.800	10.400	0.386	0.409
L1	2.900 TYP.		0.114 TYP.	
L2	1.400	1.700	0.055	0.067
L3	1.600 TYP.		0.063 TYP.	
L4	0.600	1.000	0.024	0.039
φ	1.100	1.300	0.043	0.051
θ	0°	8°	0°	8°
h	0.000	0.300	0.000	0.012
V	5.350 TYP.		0.211 TYP.	