

TGD N-Channel Enhancement Mode Power MOSFET

Description

The TGD75H21TB uses advanced trench technology and design to provide excellent $R_{DS(ON)}$ with low gate charge. It can be used in a wide variety of applications.

General Features

- $V_{DS} = 75V, I_D = 210A$
 $R_{DS(ON)} < 4.0m\Omega @ V_{GS}=10V$ (Typ3.3m Ω)
- Special process technology for high ESD capability
- High density cell design for ultra low R_{dson}
- Fully characterized avalanche voltage and current
- Good stability and uniformity with high E_{AS}
- Excellent package for good heat dissipation

Application

- Power switching application
- Hard switched and high frequency circuits
- Uninterruptible power supply

100% UIS TESTED!

100% ΔV_d s TESTED!



Schematic diagram

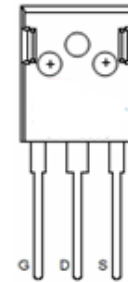

pin assignment

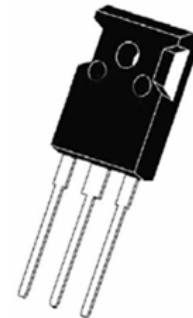

TO-220-3L top view

Package Marking and Ordering Information

Device Marking	Device	Device Package	Reel Size	Tape width	Quantity
75H21TB	75H21TB	TO-247	-	-	-

Absolute Maximum Ratings ($T_C=25^\circ C$ unless otherwise noted)

Parameter	Symbol	Limit	Unit
Drain-Source Voltage	V_{DS}	75	V
Gate-Source Voltage	V_{GS}	± 20	V
Drain Current-Continuous	I_D	210	A
Drain Current-Continuous($T_C=100^\circ C$)	$I_D(100^\circ C)$	148	A
Pulsed Drain Current	I_{DM}	850	A
Maximum Power Dissipation	P_D	330	W



Derating factor		2.2	W/°C
Single pulse avalanche energy ^(Note 5)	E _{AS}	2200	mJ
Operating Junction and Storage Temperature Range	T _J , T _{STG}	-55 To 175	°C

Thermal Characteristic

Thermal Resistance, Junction-to-Case ^(Note 2)	R _{θJc}	0.45	°C/W
--	------------------	------	------

Electrical Characteristics (T_C=25 °C unless otherwise noted)

Parameter	Symbol	Condition	Min	Typ	Max	Unit
Off Characteristics						
Drain-Source Breakdown Voltage	BV _{DSS}	V _{GS} =0V, I _D =250μA	75	-	-	V
Zero Gate Voltage Drain Current	I _{DSS}	V _{DS} =75V, V _{GS} =0V	-	-	1	μA
Gate-Body Leakage Current	I _{GSS}	V _{GS} =±20V, V _{DS} =0V	-	-	±100	nA
On Characteristics ^(Note 3)						
Gate Threshold Voltage	V _{GS(th)}	V _{DS} =V _{GS} , I _D =250μA	2	3	4	V
Drain-Source On-State Resistance	R _{DS(ON)}	V _{GS} =10V, I _D =40A	-	3.3	4.0	mΩ
Forward Transconductance	g _{FS}	V _{DS} =5V, I _D =40A	60	-	-	S
Dynamic Characteristics ^(Note 4)						
Input Capacitance	C _{iss}	V _{DS} =30V, V _{GS} =0V, F=1.0MHz	-	9400	-	PF
Output Capacitance	C _{oss}		-	880	-	PF
Reverse Transfer Capacitance	C _{rss}		-	520	-	PF
Switching Characteristics ^(Note 4)						
Turn-on Delay Time	t _{d(on)}	V _{DD} =30V, R _L =1Ω V _{GS} =10V, R _{GEN} =2.5Ω	-	26.3	-	nS
Turn-on Rise Time	t _r		-	48.8	-	nS
Turn-Off Delay Time	t _{d(off)}		-	87.5	-	nS
Turn-Off Fall Time	t _f		-	30	-	nS
Total Gate Charge	Q _g	V _{DS} =30V, I _D =30A, V _{GS} =10V	-	228	-	nC
Gate-Source Charge	Q _{gs}		-	66	-	nC
Gate-Drain Charge	Q _{gd}		-	36	-	nC
Drain-Source Diode Characteristics						
Diode Forward Voltage ^(Note 3)	V _{SD}	V _{GS} =0V, I _S =20A	-	-	1.2	V
Diode Forward Current ^(Note 2)	I _S	-	-	-	110	A
Reverse Recovery Time	t _{rr}	T _J = 25°C, I _F = 40A di/dt = 100A/μs ^(Note3)	-	53	-	nS
Reverse Recovery Charge	Q _{rr}		-	123	-	nC
Forward Turn-On Time	t _{on}	Intrinsic turn-on time is negligible (turn-on is dominated by LS+LD)				

Notes:

1. Repetitive Rating: Pulse width limited by maximum junction temperature.
2. Surface Mounted on FR4 Board, t ≤ 10 sec.
3. Pulse Test: Pulse Width ≤ 300μs, Duty Cycle ≤ 2%.
4. Guaranteed by design, not subject to production
5. EAS condition: T_j=25°C, V_{DD}=37.5V, V_G=10V, L=0.5mH, R_g=25Ω

Test circuit

1) E_{AS} test Circuit



2) Gate charge test Circuit



3) Switch Time Test Circuit

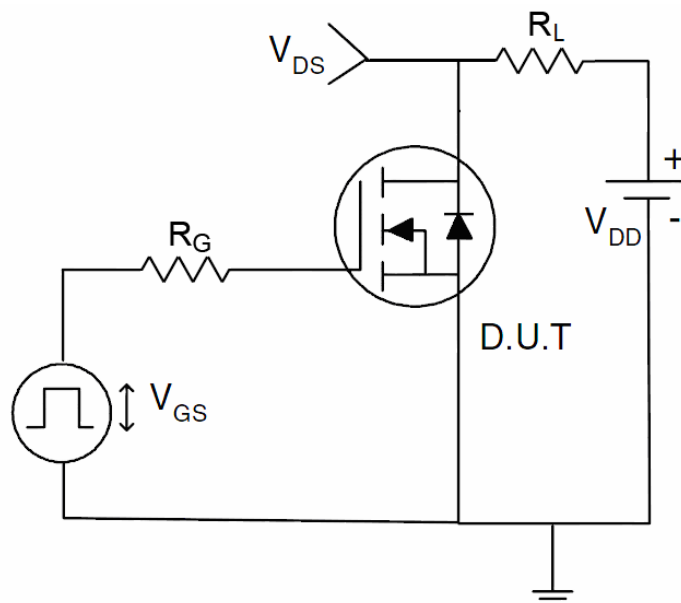

Typical Electrical and Thermal Characteristics (Curves)

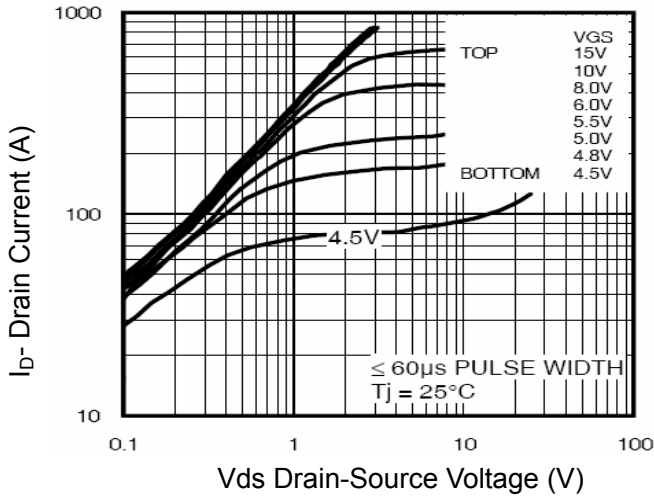

Figure 1 Output Characteristics

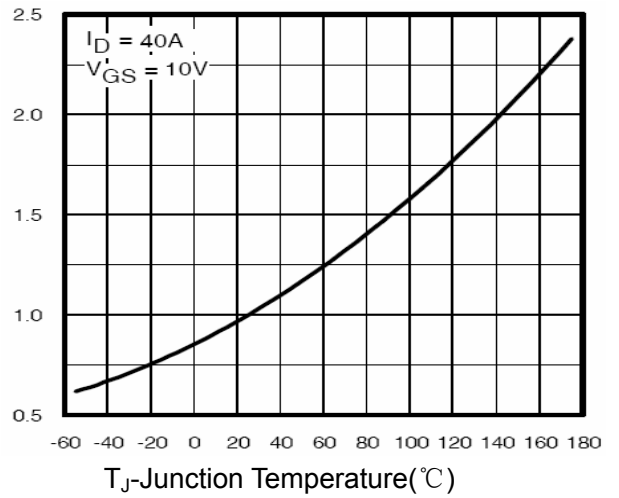

Figure 4 Rds(on)-Junction Temperature

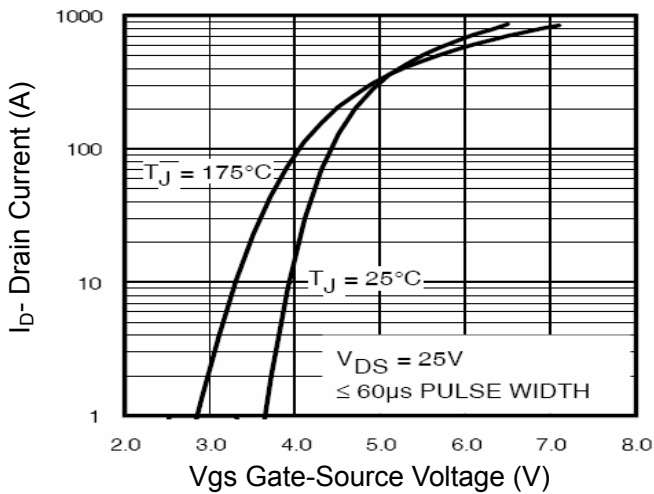

Figure 2 Transfer Characteristics

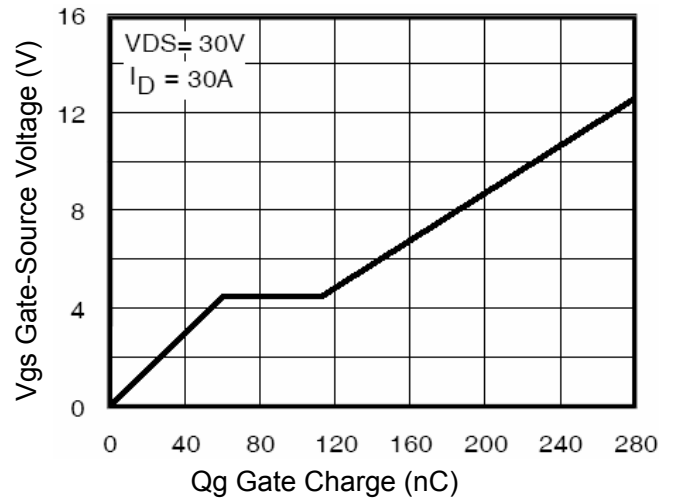

Figure 5 Gate Charge

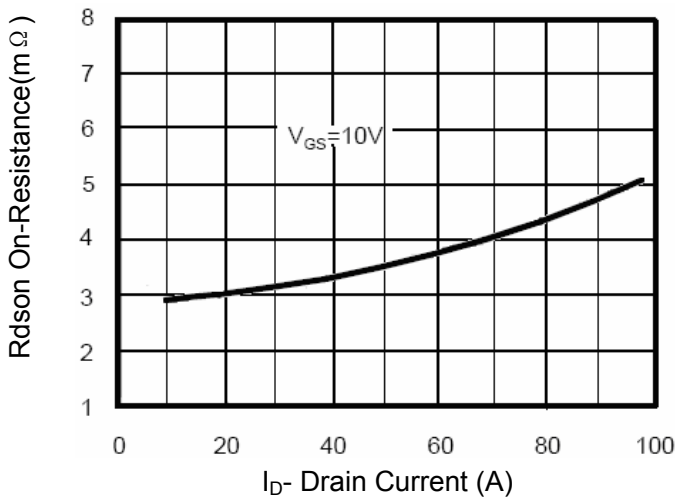

Figure 3 Rds(on)- Drain Current

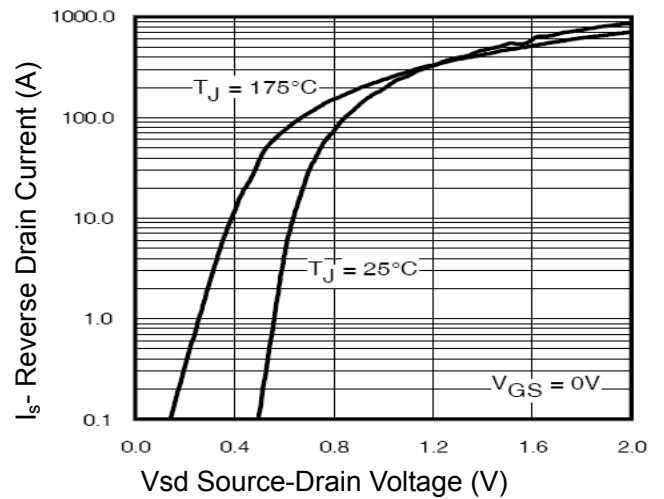

Figure 6 Source- Drain Diode Forward

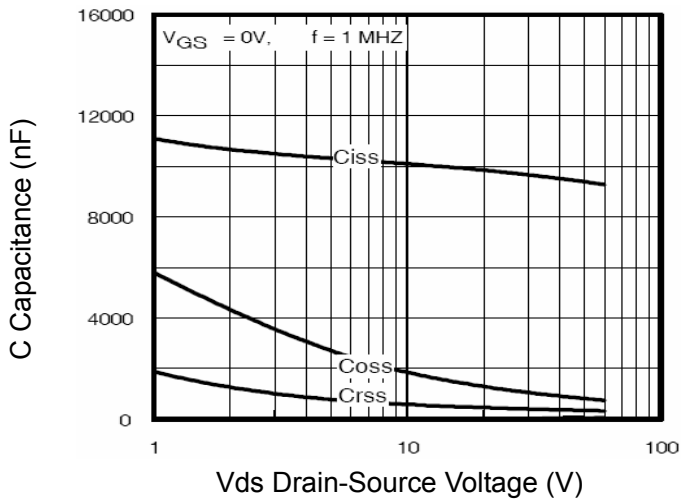

Figure 7 Capacitance vs Vds

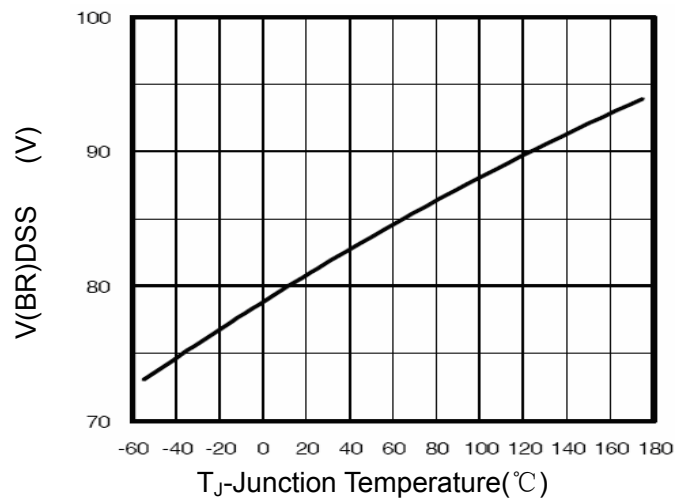

Figure 9 BV_{DSS} vs Junction Temperature

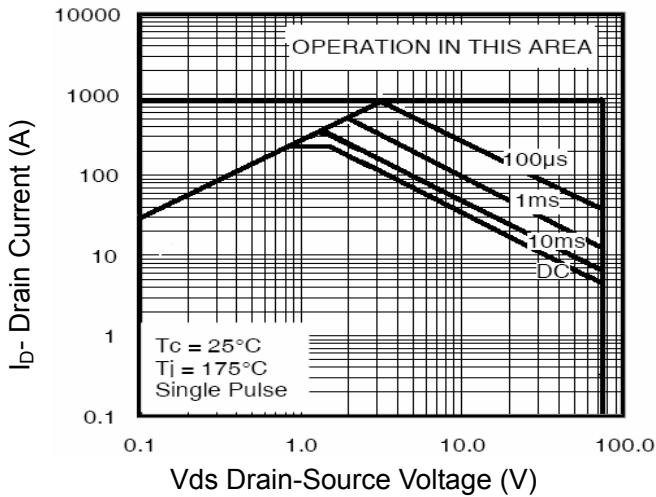

Figure 8 Safe Operation Area

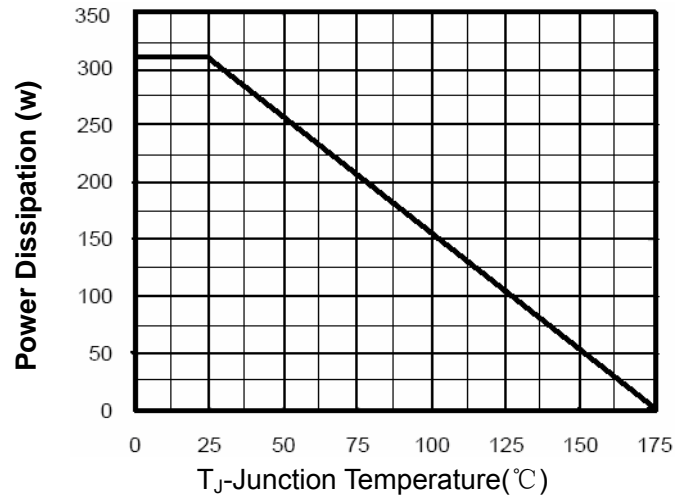

Figure 10 Power De-rating

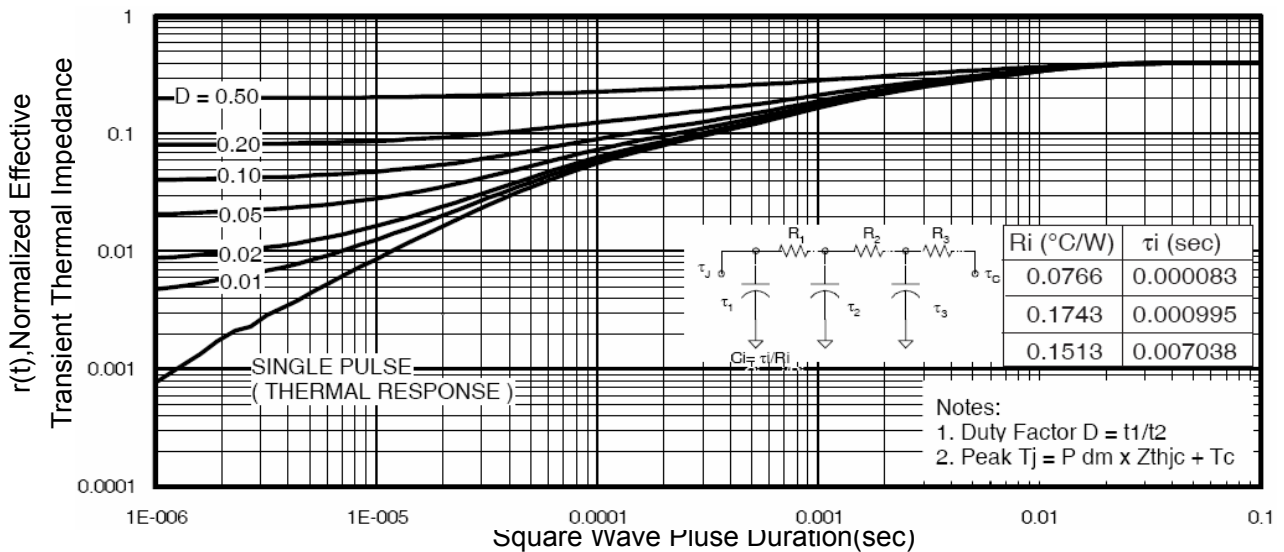
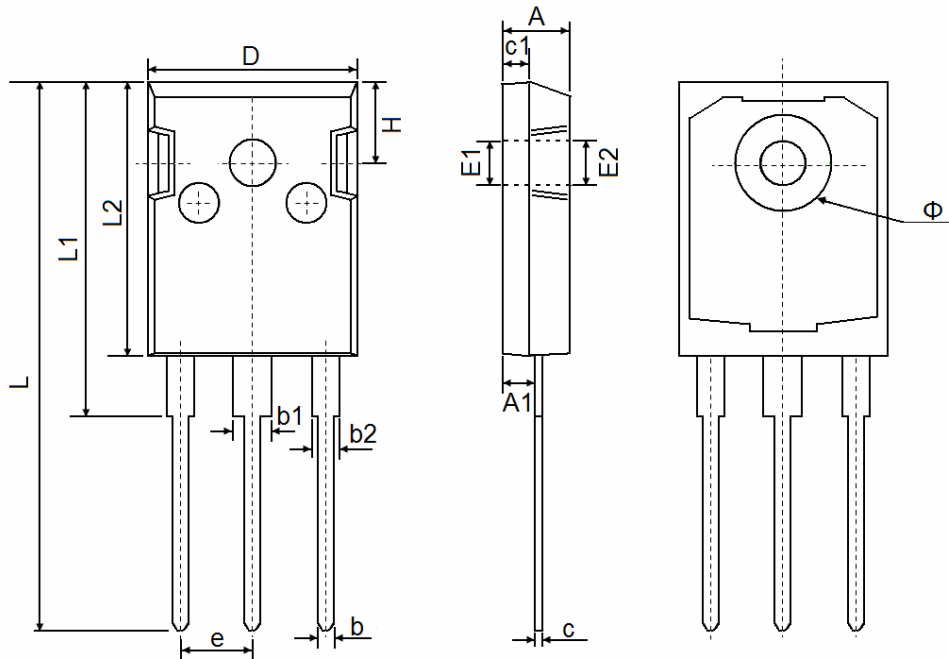

Figure 11 Normalized Maximum Transient Thermal Impedance

TO-247 Package Information



Symbol	Dimensions In Millimeters		Dimensions In Inches	
	Min.	Max.	Min.	Max.
A	4.850	5.150	0.191	0.200
A1	2.200	2.600	0.087	0.102
b	1.000	1.400	0.039	0.055
b1	2.800	3.200	0.110	0.126
b2	1.800	2.200	0.071	0.087
c	0.500	0.700	0.020	0.028
c1	1.900	2.100	0.075	0.083
D	15.450	15.750	0.608	0.620
E1	3.500 REF		0.138 REF	
E2	3.600 REF		0.142 REF	
L	40.900	41.300	1.610	1.626
L1	24.800	25.100	0.976	0.988
L2	20.300	20.600	0.799	0.811
φ	7.100	7.300	0.280	0.287
e	5.450 TYP		0.215 TYP	
H	5.980 REF		0.235 REF	