

TGD N-Channel Enhancement Mode Power MOSFET

**Description**

The TGD20H18 uses advanced trench technology and design to provide excellent  $R_{DS(ON)}$  with low gate charge. It can be used in a wide variety of applications.

**General Features**

- $V_{DS} = 20V, I_D = 185A$   
 $R_{DS(ON)} < 2.0 m\Omega @ V_{GS} = 4.5V$   
 $R_{DS(ON)} < 2.4m\Omega @ V_{GS} = 2.5V$
- High density cell design for ultra low  $R_{dson}$
- Fully characterized avalanche voltage and current
- Good stability and uniformity with high  $E_{AS}$
- Excellent package for good heat dissipation
- Special process technology for high ESD capability

**Application**

- Power switching application
- Hard switched and high frequency circuits
- Uninterruptible power supply

**100% UIS TESTED!**

**100%  $\Delta V_d$ s TESTED!**

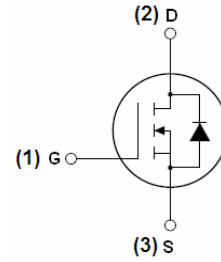

Schematic diagram

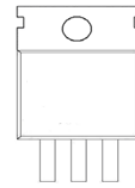

pin assignment

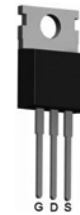

TO-220-3L top view

**Package Marking and Ordering Information**

Device Marking	Device	Device Package	Reel Size	Tape width	Quantity
TGD30H15	TGD30H15	TO-220-3L	-	-	-

**Absolute Maximum Ratings ( $T_C = 25^\circ C$  unless otherwise noted)**

Parameter	Symbol	Limit	Unit
Drain-Source Voltage	$V_{DS}$	20	V
Gate-Source Voltage	$V_{GS}$	$\pm 12$	V
Drain Current-Continuous	$I_D$	185	A
Drain Current-Continuous( $T_C = 100^\circ C$ )	$I_D (100^\circ C)$	130	A
Pulsed Drain Current	$I_{DM}$	400	A
Maximum Power Dissipation	$P_D$	130	W
Derating factor		0.87	W/ $^\circ C$
Single pulse avalanche energy <sup>(Note 5)</sup>	$E_{AS}$	1700	mJ



Operating Junction and Storage Temperature Range	$T_J, T_{STG}$	-55 To 175	°C
--	----------------	------------	----

**Thermal Characteristic**

Thermal Resistance, Junction-to-Case <sup>(Note 2)</sup>	$R_{\theta JC}$	1.15	°C/W
--	-----------------	------	------

**Electrical Characteristics ( $T_C=25^\circ\text{C}$  unless otherwise noted)**

Parameter	Symbol	Condition	Min	Typ	Max	Unit
<b>Off Characteristics</b>						
Drain-Source Breakdown Voltage	$BV_{DSS}$	$V_{GS}=0V, I_D=250\mu A$	20	-	-	V
Zero Gate Voltage Drain Current	$I_{DSS}$	$V_{DS}=20V, V_{GS}=0V$	-	-	1	$\mu A$
Gate-Body Leakage Current	$I_{GSS}$	$V_{GS}=\pm 12V, V_{DS}=0V$	-	-	$\pm 100$	nA
<b>On Characteristics</b> <sup>(Note 3)</sup>						
Gate Threshold Voltage	$V_{GS(th)}$	$V_{DS}=V_{GS}, I_D=250\mu A$	0.5	0.75	1.2	V
Drain-Source On-State Resistance	$R_{DS(on)}$	$V_{GS}=4.5V, I_D=20A$	-	1.4	2.0	m $\Omega$
		$V_{GS}=2.5V, I_D=15A$	-	1.6	2.4	
Forward Transconductance	$g_{FS}$	$V_{DS}=5V, I_D=20A$	100	-	-	S
<b>Dynamic Characteristics</b> <sup>(Note 4)</sup>						
Input Capacitance	$C_{iss}$	$V_{DS}=10V, V_{GS}=0V,$ $F=1.0MHz$	-	5000	-	PF
Output Capacitance	$C_{oss}$		-	1200	-	PF
Reverse Transfer Capacitance	$C_{rss}$		-	900	-	PF
<b>Switching Characteristics</b> <sup>(Note 4)</sup>						
Turn-on Delay Time	$t_{d(on)}$	$V_{DD}=10V, I_D=2A, R_L=15\Omega$ $V_{GS}=10V, R_G=2.5\Omega$	-	12	-	nS
Turn-on Rise Time	$t_r$		-	13	-	nS
Turn-Off Delay Time	$t_{d(off)}$		-	45	-	nS
Turn-Off Fall Time	$t_f$		-	32	-	nS
Total Gate Charge	$Q_g$	$V_{DS}=10V, I_D=20A,$ $V_{GS}=10V$	-	70	-	nC
Gate-Source Charge	$Q_{gs}$		-	16	-	nC
Gate-Drain Charge	$Q_{gd}$		-	20	-	nC
<b>Drain-Source Diode Characteristics</b>						
Diode Forward Voltage <sup>(Note 3)</sup>	$V_{SD}$	$V_{GS}=0V, I_S=20A$	-	-	1.2	V
Diode Forward Current <sup>(Note 2)</sup>	$I_S$		-	-	150	A
Reverse Recovery Time	$t_{rr}$	$T_J = 25^\circ\text{C}, I_F = 20A$ $di/dt = 100A/\mu s$ <sup>(Note 3)</sup>	-	49	-	nS
Reverse Recovery Charge	$Q_{rr}$		-	66	-	nC
Forward Turn-On Time	$t_{on}$	Intrinsic turn-on time is negligible (turn-on is dominated by LS+LD)				

**Notes:**

1. Repetitive Rating: Pulse width limited by maximum junction temperature.
2. Surface Mounted on FR4 Board,  $t \leq 10$  sec.
3. Pulse Test: Pulse Width  $\leq 300\mu s$ , Duty Cycle  $\leq 2\%$ .
4. Guaranteed by design, not subject to production
5.  $E_{AS}$  condition :  $T_J=25^\circ\text{C}, V_{DD}=20V, V_G=10V, L=1mH, R_g=25\Omega, I_{AS}=58.5A$

**Test circuit**

**1) E<sub>AS</sub> Test Circuit**

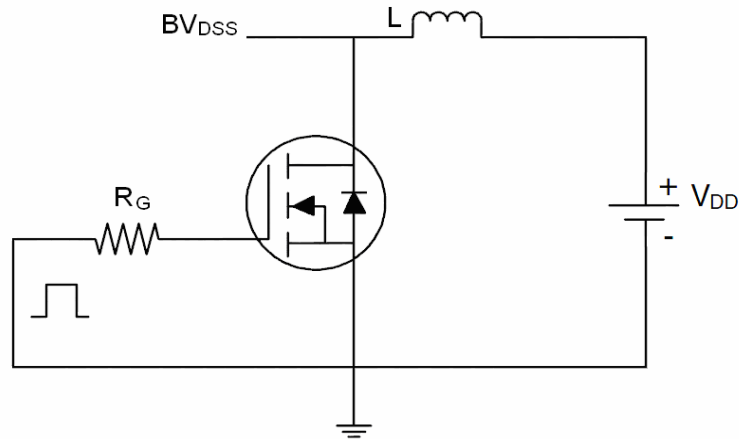

**2) Gate Charge Test Circuit**



**3) Switch Time Test Circuit**

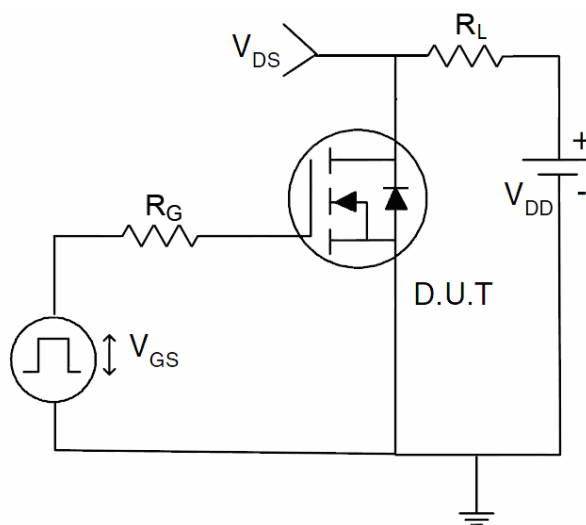

**Typical Electrical and Thermal Characteristics (Curves)**

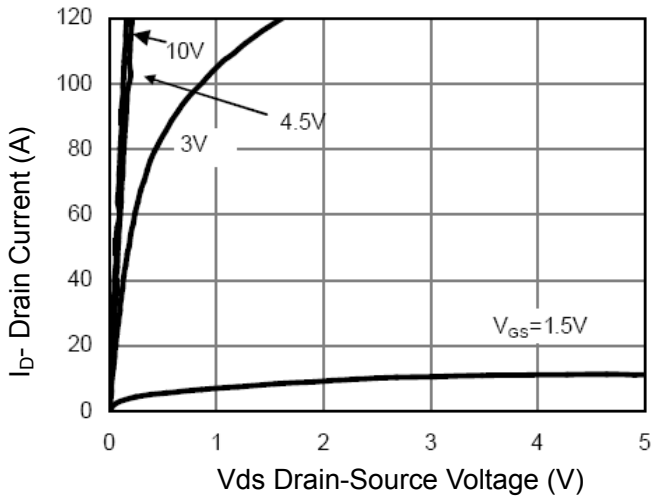

**Figure 1 Output Characteristics**

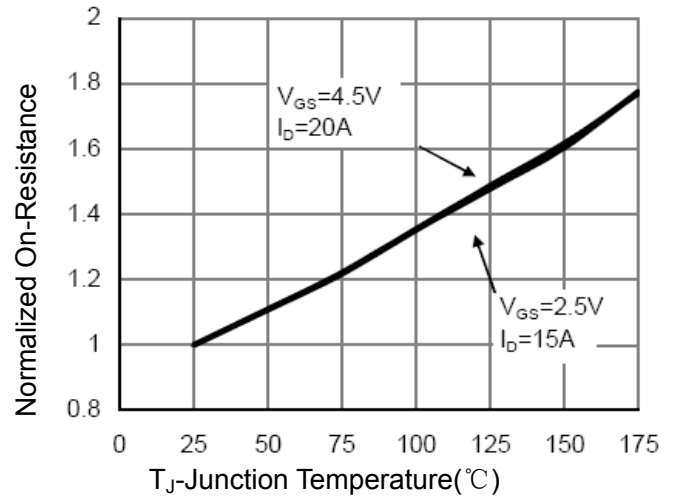

**Figure 4 Rds(on)-Junction Temperature**

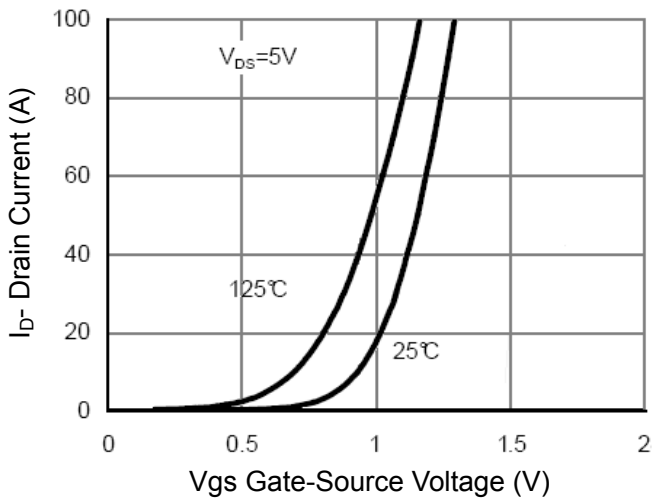

**Figure 2 Transfer Characteristics**

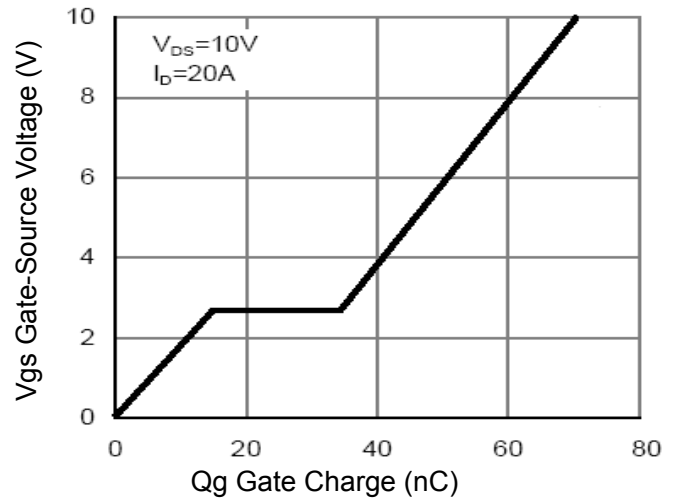

**Figure 5 Gate Charge**

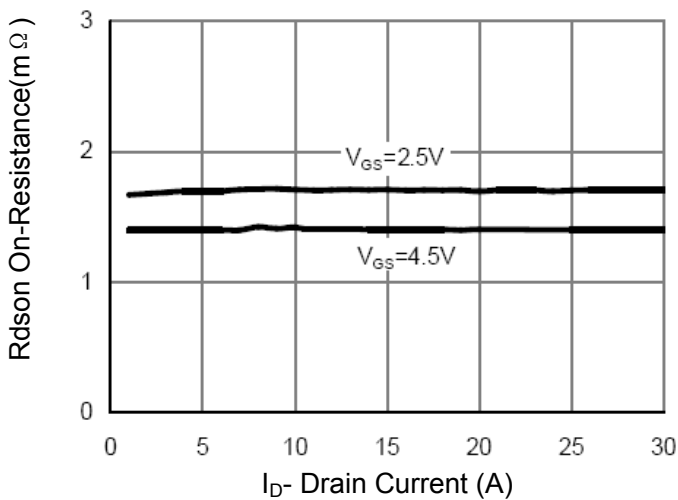

**Figure 3 Rds(on)- Drain Current**

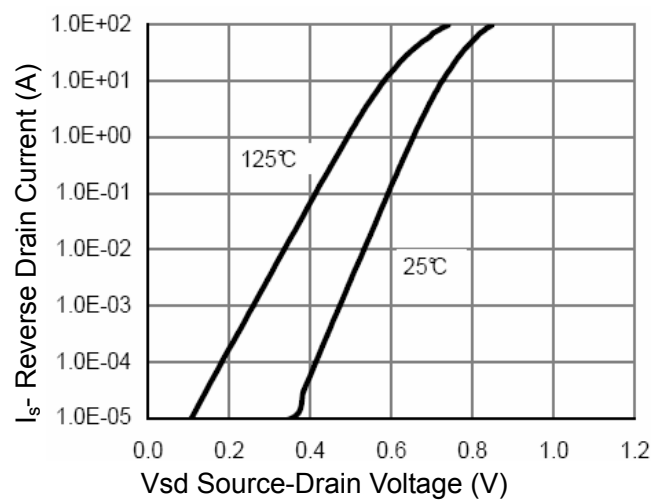

**Figure 6 Source- Drain Diode Forward**

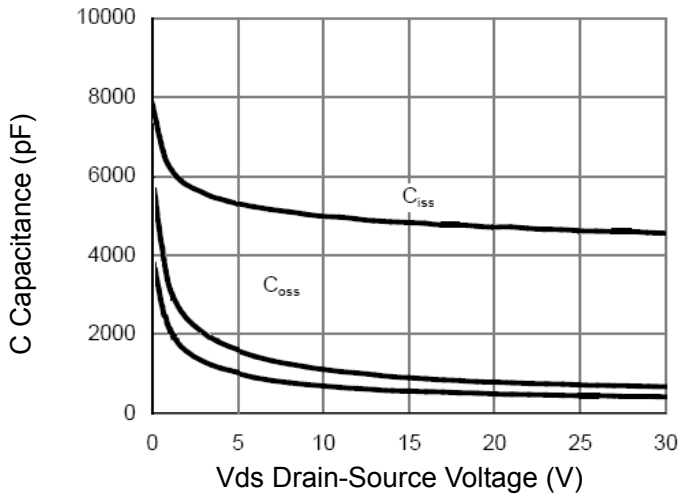

Figure 7 Capacitance vs Vds

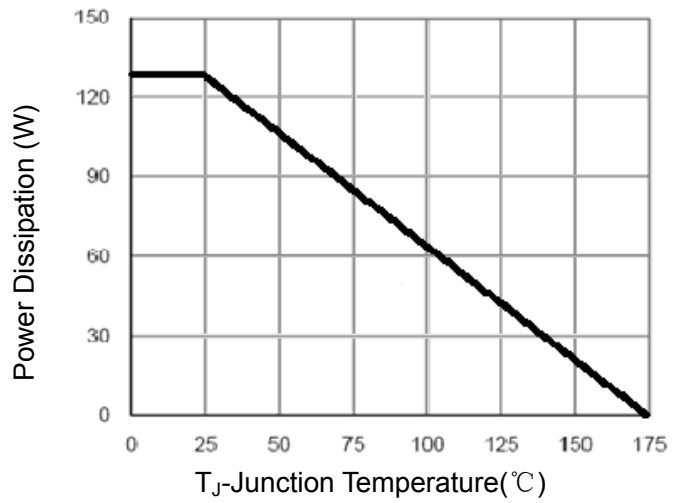

Figure 9 Power De-rating

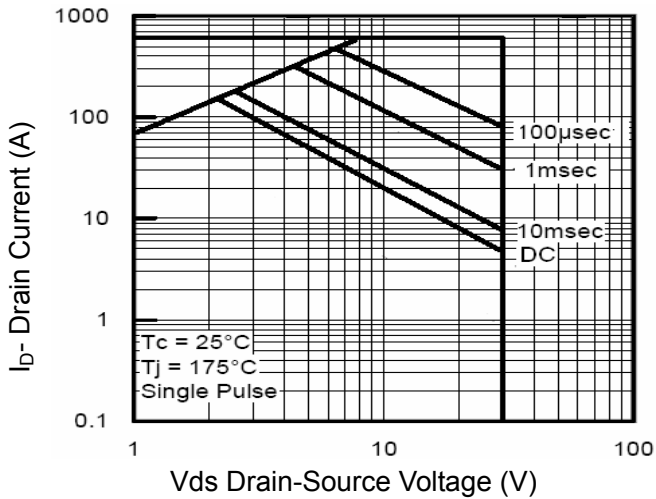

Figure 8 Safe Operation Area

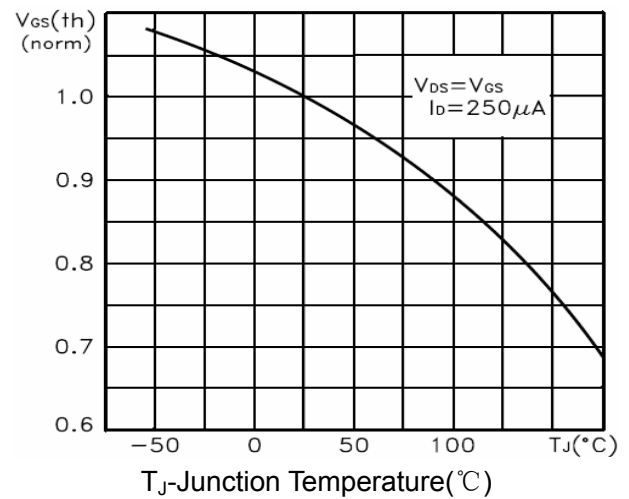

Figure 10 V<sub>GS(th)</sub> vs Junction Temperature

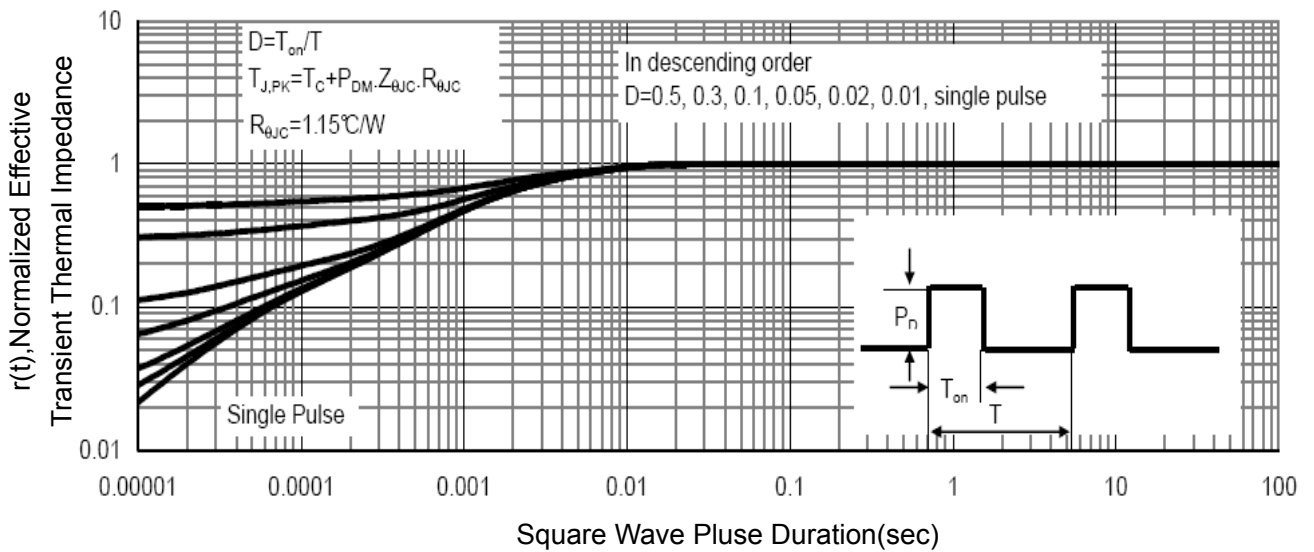
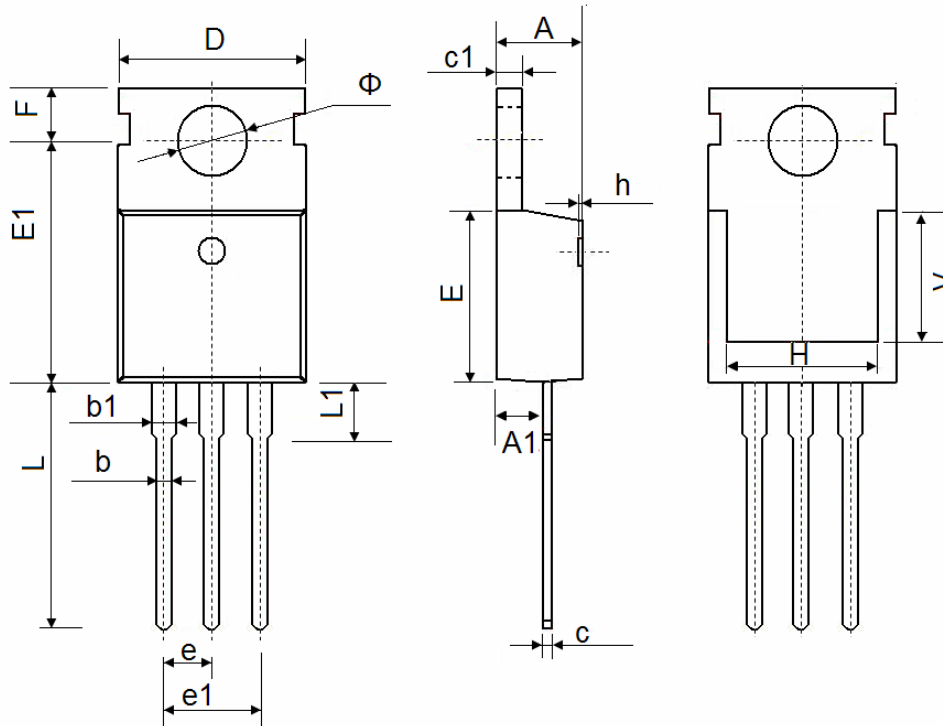

Figure 11 Normalized Maximum Transient Thermal Impedance

TO-220-3L Package Information



Symbol	Dimensions In Millimeters		Dimensions In Inches	
	Min.	Max.	Min.	Max.
A	4.400	4.600	0.173	0.181
A1	2.250	2.550	0.089	0.100
b	0.710	0.910	0.028	0.036
b1	1.170	1.370	0.046	0.054
c	0.330	0.650	0.013	0.026
c1	1.200	1.400	0.047	0.055
D	9.910	10.250	0.390	0.404
E	8.9500	9.750	0.352	0.384
E1	12.650	12.950	0.498	0.510
e	2.540 TYP.		0.100 TYP.	
e1	4.980	5.180	0.196	0.204
F	2.650	2.950	0.104	0.116
H	7.900	8.100	0.311	0.319
h	0.000	0.300	0.000	0.012
L	12.900	13.400	0.508	0.528
L1	2.850	3.250	0.112	0.128
V	7.500 REF.		0.295 REF.	
Φ	3.400	3.800	0.134	0.150